

○ GRAND FLOOR PLAN
S.A.B

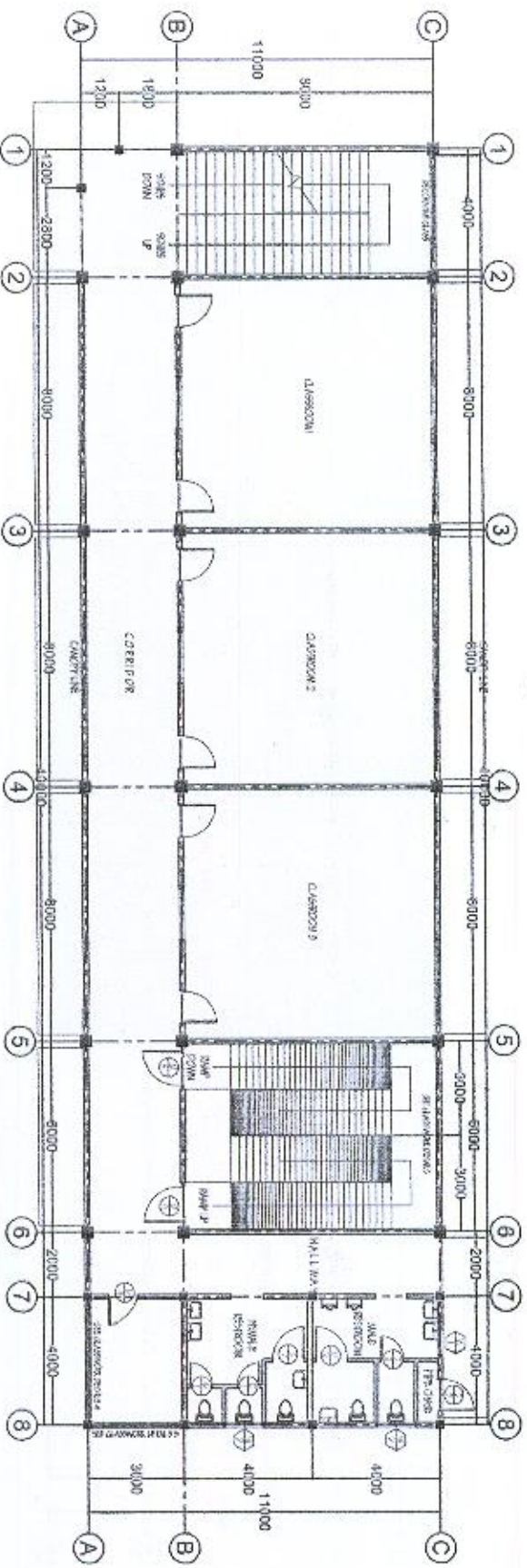

○ SECOND FLOOR PLAN
S.A.B

 <p>WEST VISAYAS STATE UNIVERSITY MAIN CAMPUS 1544, K. LOLO CITY, PAMPANES CAMPUS PHYSICAL PLANNING OFFICE</p>	<p>DESIGNED BY: <i>[Signature]</i> SCHOOL OF ARCHITECTURE UNIVERSITY OF VISAYAS</p>	<p>CHECKED BY: <i>[Signature]</i> ARCHITECTURAL ENGINEER UNIVERSITY OF VISAYAS</p>	<p>NOTES: <i>[Signature]</i> CONSTRUCTION OF SECOND FLOOR UNIVERSITY OF VISAYAS</p>	<p>CONFERRED BY: <i>[Signature]</i> REVIEWING FLOOR PLAN UNIVERSITY OF VISAYAS</p>	<p>APPROVED BY: <i>[Signature]</i> SCHOOL OF ARCHITECTURE UNIVERSITY OF VISAYAS</p>	<p>DATE: 03/04/2024 CPU BY: JPM</p>	<p>SHEET NUMBER: 49 of 40000</p>	<p>PAGES: 1 6</p>
	<p>PROJECT TITLE: Architectural & Engineering Works of 2nd Amenity Building</p>	<p>PROJECT LOCATION: UNIVERSITY OF VISAYAS</p>	<p>PROJECT NO.:</p>	<p>DATE OF ISSUE:</p>	<p>DATE OF REVIEW:</p>	<p>DATE OF APPROVAL:</p>	<p>SCALE:</p>	<p>PROJECT NO.:</p>

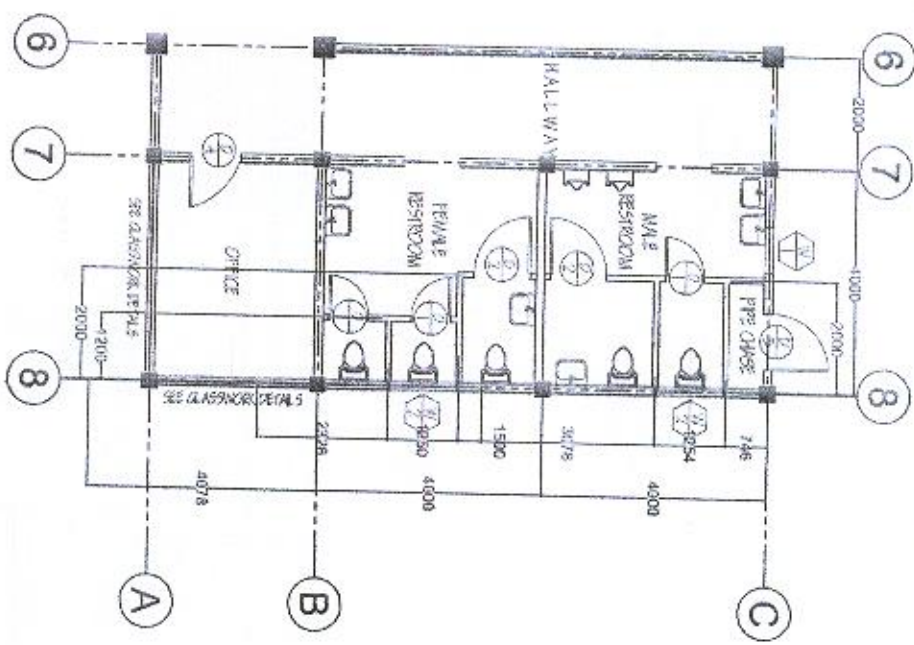

FLOW PLAN ANNEX

NOTE:

Wall of the office is composed of 4" CHB with vertical 10mm RSB support spaced @ 80cm O.C and horizontal 10mm RSB support @ every 3 layers

Add 2 layers of 4" CHB on the existing Railings at the Office Room. Apply concrete epoxy to act as a binder to old concrete and new concrete as well as the steel to concrete connections

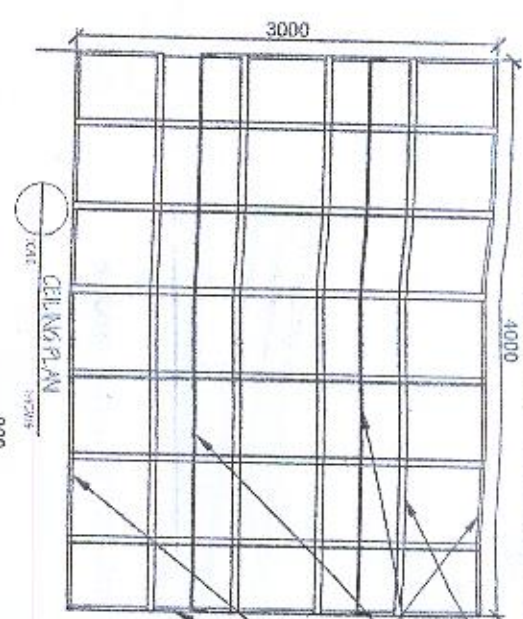

Metal Furring 15mmx50mmx0.5mm
 Carrying Channel 12mmx38mmx0.8mm
 Wall Angle 25mmx25mm

NOTE:
 *Carrying Channel spaced @ 1.2m O.C
 *Metal Furring spaced @ 0.8m O.C

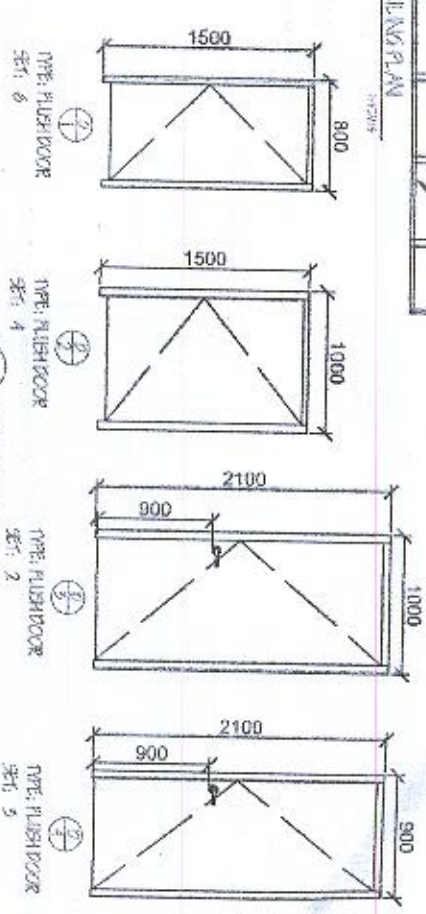

SCHEDULE OF DOORS

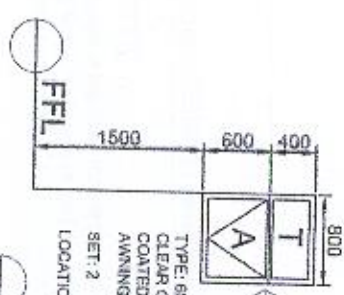

SCHEDULE OF WINDOWS

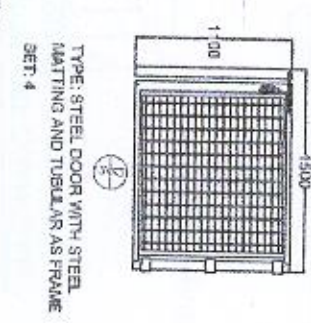

SCHEDULE OF STEEL DOOR

<p>WEST VISAYAS STATE UNIVERSITY 6SM CAMPUS LA FAYE BLDG. CITY, PHILIPPINES CAMPUS PHYSICAL PLANNING OFFICE</p>	<p>PREPARED BY: </p>	<p>PROJECT TITLE: Architectural & Engineering Works of 3rd Annex Building</p>	<p>CHECKED BY: </p>	<p>NO. OF SHEETS: 3</p>	<p>DATE: 03/04/2024</p>	<p>SHEET CONTENT: AS SHOWN</p>	<p>SCALE: 3/6</p>
	<p>ARCHITECT: </p>	<p>DESIGNED BY: </p>	<p>DATE OF ISSUE: 03/04/2024</p>	<p>APPROVED BY: </p>	<p>DATE OF APPROVAL: 03/04/2024</p>	<p>DATE OF ISSUE: 03/04/2024</p>	<p>DATE OF APPROVAL: 03/04/2024</p>

WATER TANK STAND, WATER PUMP STAND AND STEEL RUNG DETAILS

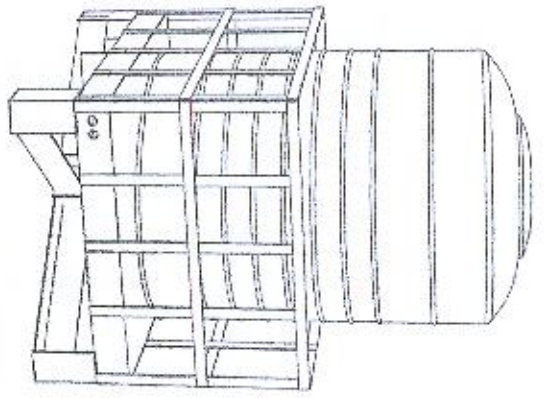

○ Perspective Water Tank Stand

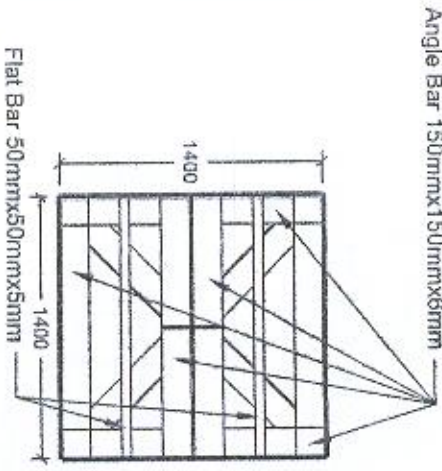

○ Top View Water Tank Stand
Scale 1:30

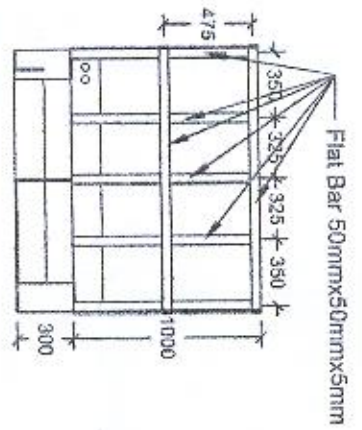

○ Front View Water Tank Stand
Scale 1:30

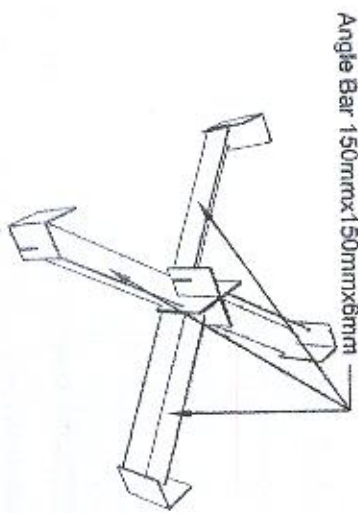

○ Details Water Tank Stand Main Supports

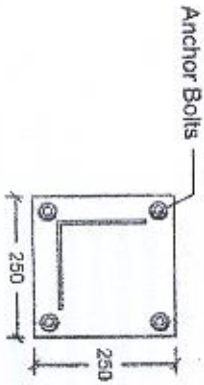

○ Top View Water Tank Stand Connection
Scale 1:10

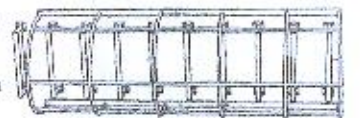

○ Perspective Ladder Rung

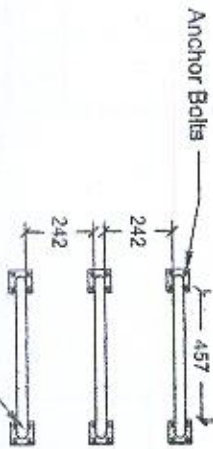

○ Ladder Rung Section Details
Scale 1:20

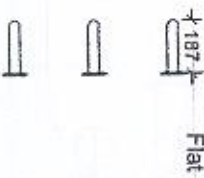

○ Side Ladder Rung Section Details
Scale 1:20

○ 1/2" SS Round Bar 304

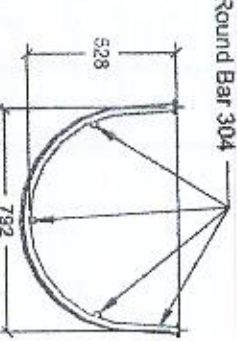

○ Top View Ladder Rung Casing
Scale 1:20

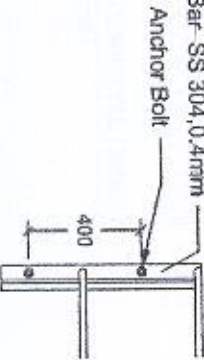

○ Ladder Rung Casing Support Detail
Scale 1:20

NOTE:

* Water Tank System is consist of 2 2000L vertical steel Water Tanks

* Automatic Level Control Bulb will be installed on both water tanks

* Size may vary depending the size of the Vertical Water Tank

* Provide housing for the Water Pump

SIZING OF TRANSMFER PUMP DATA:

CAP ENT * 2400 US GALS

FILLING TIME = 60 min
Q = 40.15 GPM

COMPUTED TOTAL DYNAMIC HEAD = 100FT
HORSE POWER REQUIREMENT

HP = 1.59
USE APPROX. 1-2.0 WATER PUMP
CAP = 40.16 GPM VS 100 FT (TDH)
PUMP EFF = 90%



WEST VISAYAS STATE UNIVERSITY
MAIN CAMPUS
LA PAZ, ILOILO CITY, PHILIPPINES
CAMPAUS PHYSICAL PLANNING OFFICE

DESIGNED BY:
ARCHITECTURAL & ENGINEERING WORKS OF 307E
ARMA BUILDING
1000 LA PAZ, ILOILO CITY

CHECKED BY:
REGISTERED ELECTRICAL ENGINEER
1000 LA PAZ, ILOILO CITY

NOTES:
PROFESSIONAL ENGINEER IN ELECTRICAL ENGINEERING
1000 LA PAZ, ILOILO CITY

CONSULTANT & SITE
REGISTERED ELECTRICAL ENGINEER
1000 LA PAZ, ILOILO CITY

RECOMMENDING APPROVAL
REGISTERED ELECTRICAL ENGINEER
1000 LA PAZ, ILOILO CITY

APPROVED BY:
REGISTERED ELECTRICAL ENGINEER
1000 LA PAZ, ILOILO CITY

DATE: 03/04/2024
SHEET CONTENT: AS SHOWN
PAGE: 5/6

GLASSWORK DETAILS

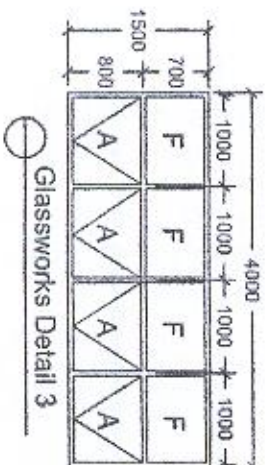
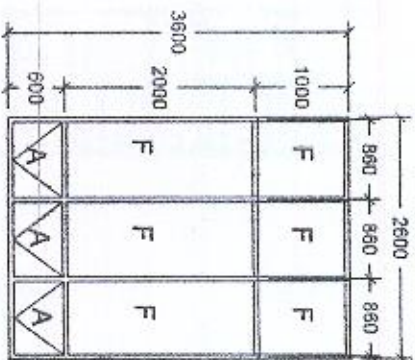
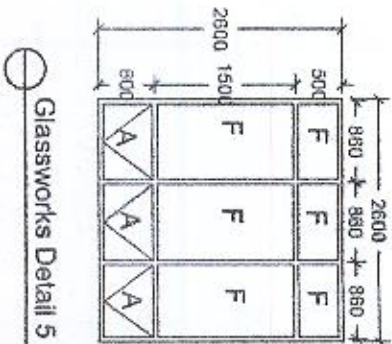
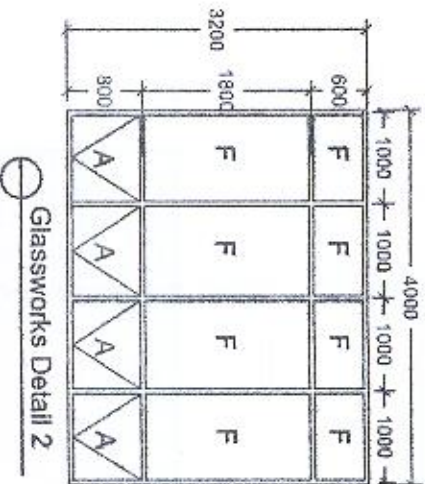
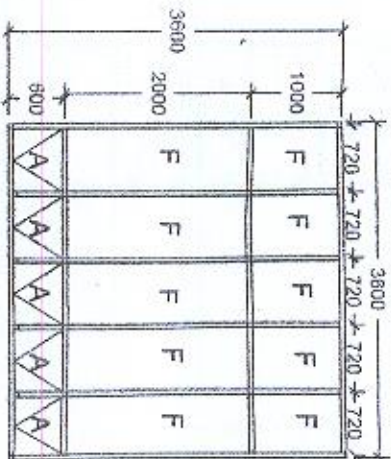
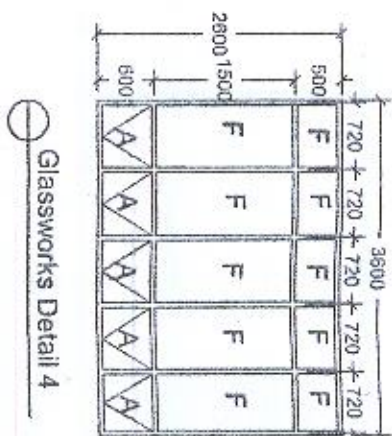
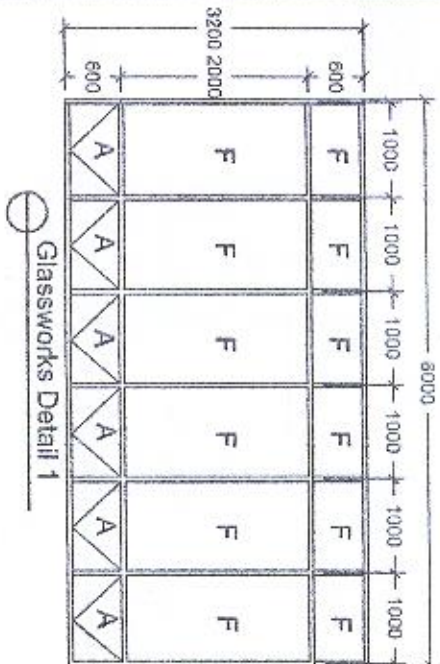

NOTE:
 *Dimensions may differ from the plan as per actual spacing/size of the columns/beams, number of partition as well as the height of the awning windows will prevail
 *Decorative glass from the 1st floor will be designed as a logo of WVSU Janitery and SOTE

	WEST VISAYAS STATE UNIVERSITY SAN CARLOS LA PAZ, ILOILO CITY, PHILIPPINES CAMPUS PHYSICAL PLANNING OFFICE	PREPARED BY: 	PROJECT TITLE: Architectural & Engineering Works of SOTE Annex Building	CHECKED BY: 	NOTED: FLORENCE L. TORRES, JR. MGT. ANCHOR	CONCLUDED BY: 	RECOMMENDED APPROVAL: 	DATED BY: 03/04/2024	SHEET COMMENT: AS SHOWN	PAGES: G 1
	CIVIL ENGINEERING 2020-2024	CIVIL ENGINEER	ARCHITECTURAL & ENGINEERING WORKS OF SOTE ANNEX BUILDING	ZORRO GARCIA, BAREZ	FLORENCE L. TORRES, JR. MGT. ANCHOR	REMONDE FERNANDEZ	ZULFIN FERNANDEZ O. LIM	DR. JOSELUIS VILARQUEZ	JPM	CIVIL ENGINEERING



WEST VISAYAS STATE UNIVERSITY
 MAIN CAMPUS
 LAPOZ, DALOG CITY, PHE, PANAY
 CAMPAUS PHYSICAL PLANNING OFFICE

PREPARED BY
 ENGR. JUSTIN VILLAN, MAJADO

PROJECT TITLE
 Architecture & Engineering Works of SCOT
 Annex Building

DESIGNED BY
 ARCH. FERDINAND B. BERNIZ

NOISE BY
 FLORENCE L. CUNIBIDIA, PH.D. M.A. M.P.A.
 CONSULTING ENGINEER

ENGINEERED BY
 REYNALDO S. FLORES, R.P.E.
 REGISTERED PROFESSIONAL ENGINEER

RECOMMENDING APPROVAL
 MRS. JOYCE S. DELA CRUZ, R.P.E.
 REGISTERED PROFESSIONAL ENGINEER

APPROVED BY
 DR. JOSELOTT VILLASORIE
 DEAN OF ENGINEERING

DATE
 03/04/2024

SHEET CONTENT
 AS SHOWN

NO. 1

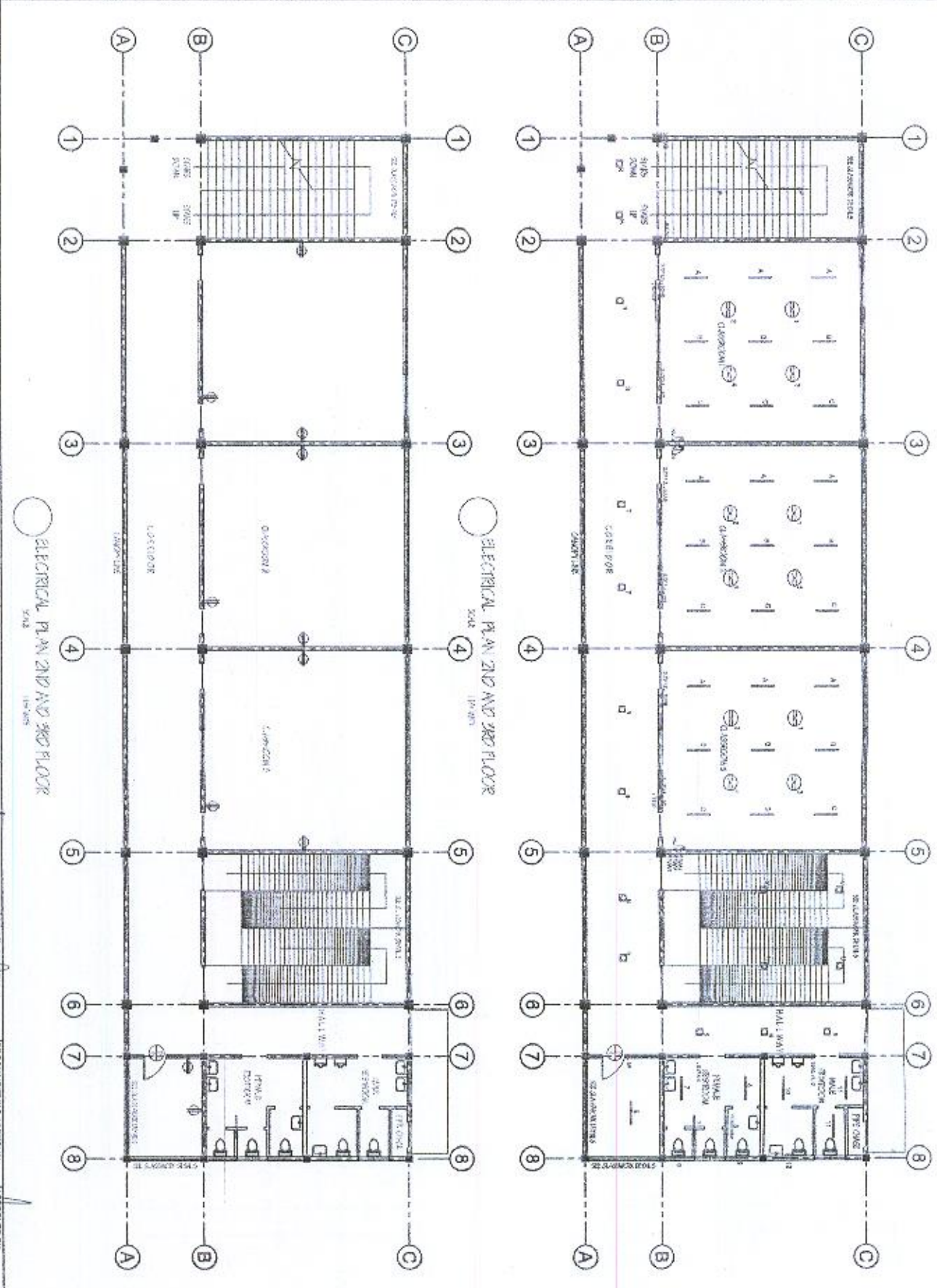

ELECTRICAL PLAN 2ND AND 3RD FLOOR

- Electrical Legend**
- 25 W Fluorescent Lamp
 - 18 W Compact Fluorescent Lamp
 - 80 W Cfla Fan
 - 100 W Cfla Fan
 - 150 W Cfla Fan
 - 200 W Cfla Fan
 - 300 W Cfla Fan
 - 400 W Cfla Fan
 - 500 W Cfla Fan
 - 600 W Cfla Fan
 - 700 W Cfla Fan
 - 800 W Cfla Fan
 - 900 W Cfla Fan
 - 1000 W Cfla Fan
 - 1100 W Cfla Fan
 - 1200 W Cfla Fan
 - 1300 W Cfla Fan
 - 1400 W Cfla Fan
 - 1500 W Cfla Fan
 - 1600 W Cfla Fan
 - 1700 W Cfla Fan
 - 1800 W Cfla Fan
 - 1900 W Cfla Fan
 - 2000 W Cfla Fan
 - 2100 W Cfla Fan
 - 2200 W Cfla Fan
 - 2300 W Cfla Fan
 - 2400 W Cfla Fan
 - 2500 W Cfla Fan
 - 2600 W Cfla Fan
 - 2700 W Cfla Fan
 - 2800 W Cfla Fan
 - 2900 W Cfla Fan
 - 3000 W Cfla Fan
 - 3100 W Cfla Fan
 - 3200 W Cfla Fan
 - 3300 W Cfla Fan
 - 3400 W Cfla Fan
 - 3500 W Cfla Fan
 - 3600 W Cfla Fan
 - 3700 W Cfla Fan
 - 3800 W Cfla Fan
 - 3900 W Cfla Fan
 - 4000 W Cfla Fan
 - 4100 W Cfla Fan
 - 4200 W Cfla Fan
 - 4300 W Cfla Fan
 - 4400 W Cfla Fan
 - 4500 W Cfla Fan
 - 4600 W Cfla Fan
 - 4700 W Cfla Fan
 - 4800 W Cfla Fan
 - 4900 W Cfla Fan
 - 5000 W Cfla Fan
 - 5100 W Cfla Fan
 - 5200 W Cfla Fan
 - 5300 W Cfla Fan
 - 5400 W Cfla Fan
 - 5500 W Cfla Fan
 - 5600 W Cfla Fan
 - 5700 W Cfla Fan
 - 5800 W Cfla Fan
 - 5900 W Cfla Fan
 - 6000 W Cfla Fan
 - 6100 W Cfla Fan
 - 6200 W Cfla Fan
 - 6300 W Cfla Fan
 - 6400 W Cfla Fan
 - 6500 W Cfla Fan
 - 6600 W Cfla Fan
 - 6700 W Cfla Fan
 - 6800 W Cfla Fan
 - 6900 W Cfla Fan
 - 7000 W Cfla Fan
 - 7100 W Cfla Fan
 - 7200 W Cfla Fan
 - 7300 W Cfla Fan
 - 7400 W Cfla Fan
 - 7500 W Cfla Fan
 - 7600 W Cfla Fan
 - 7700 W Cfla Fan
 - 7800 W Cfla Fan
 - 7900 W Cfla Fan
 - 8000 W Cfla Fan
 - 8100 W Cfla Fan
 - 8200 W Cfla Fan
 - 8300 W Cfla Fan
 - 8400 W Cfla Fan
 - 8500 W Cfla Fan
 - 8600 W Cfla Fan
 - 8700 W Cfla Fan
 - 8800 W Cfla Fan
 - 8900 W Cfla Fan
 - 9000 W Cfla Fan
 - 9100 W Cfla Fan
 - 9200 W Cfla Fan
 - 9300 W Cfla Fan
 - 9400 W Cfla Fan
 - 9500 W Cfla Fan
 - 9600 W Cfla Fan
 - 9700 W Cfla Fan
 - 9800 W Cfla Fan
 - 9900 W Cfla Fan
 - 10000 W Cfla Fan