

# PHILIPPINE BIDDING DOCUMENTS

(As Harmonized with Development Partners)

# Procurement of GOODS

Government of the Republic of the Philippines

**PROCUREMENT OF VARIOUS FURNITURE AND FIXTURES  
FOR VARIOUS OFFICES – IB No. 2024-30**

**Php2,259,699.00**

**Sixth Edition  
July 2020**

# Preface

These Philippine Bidding Documents (PBDs) for the procurement of Goods through Competitive Bidding have been prepared by the Government of the Philippines for use by any branch, constitutional commission or office, agency, department, bureau, office, or instrumentality of the Government of the Philippines, National Government Agencies, including Government-Owned and/or Controlled Corporations, Government Financing Institutions, State Universities and Colleges, and Local Government Unit. The procedures and practices presented in this document have been developed through broad experience, and are for mandatory use in projects that are financed in whole or in part by the Government of the Philippines or any foreign government/foreign or international financing institution in accordance with the provisions of the 2016 revised Implementing Rules and Regulations of Republic Act No. 9184.

The Bidding Documents shall clearly and adequately define, among others: (i) the objectives, scope, and expected outputs and/or results of the proposed contract or Framework Agreement, as the case may be; (ii) the eligibility requirements of Bidders; (iii) the expected contract or Framework Agreement duration, the estimated quantity in the case of procurement of goods, delivery schedule and/or time frame; and (iv) the obligations, duties, and/or functions of the winning bidder.

Care should be taken to check the relevance of the provisions of the PBDs against the requirements of the specific Goods to be procured. If duplication of a subject is inevitable in other sections of the document prepared by the Procuring Entity, care must be exercised to avoid contradictions between clauses dealing with the same matter.

Moreover, each section is prepared with notes intended only as information for the Procuring Entity or the person drafting the Bidding Documents. They shall not be included in the final documents. The following general directions should be observed when using the documents:

- a. All the documents listed in the Table of Contents are normally required for the procurement of Goods. However, they should be adapted as necessary to the circumstances of the particular Procurement Project.
- b. Specific details, such as the “*name of the Procuring Entity*” and “*address for bid submission*,” should be furnished in the Instructions to Bidders, Bid Data Sheet, and Special Conditions of Contract. The final documents should contain neither blank spaces nor options.
- c. This Preface and the footnotes or notes in italics included in the Invitation to Bid, Bid Data Sheet, General Conditions of Contract, Special Conditions of Contract, Schedule of Requirements, and Specifications are not part of the text of the final document, although they contain instructions that the Procuring Entity should strictly follow.
- d. The cover should be modified as required to identify the Bidding Documents as to the Procurement Project, Project Identification Number, and Procuring Entity, in addition to the date of issue.
- e. Modifications for specific Procurement Project details should be provided in the Special Conditions of Contract as amendments to the Conditions of Contract. For easy completion, whenever reference has to be made to specific clauses in the Bid Data Sheet or Special Conditions of Contract, these terms shall be printed in bold typeface on Sections I (Instructions to Bidders) and III (General Conditions of Contract), respectively.
- f. For guidelines on the use of Bidding Forms and the procurement of Foreign-Assisted Projects, these will be covered by a separate issuance of the Government Procurement Policy Board.

# Table of Contents

<b>Section I. Invitation to Bid.....</b>	<b>5-6</b>
<b>Section II. Instructions to Bidders.....</b>	<b>7</b>
1. Scope of Bid .....	7
2. Funding Information.....	7
3. Bidding Requirements .....	7
4. Corrupt, Fraudulent, Collusive, and Coercive Practices .....	7
5. Eligible Bidders.....	7
6. Origin of Goods .....	8
7. Subcontracts .....	8
8. Pre-Bid Conference .....	8
9. Clarification and Amendment of Bidding Documents .....	9
10. Documents comprising the Bid: Eligibility and Technical Components .....	9
11. Documents comprising the Bid: Financial Component .....	9
12. Bid Prices .....	9
13. Bid and Payment Currencies .....	10
14. Bid Security .....	10
15. Sealing and Marking of Bids .....	10
16. Deadline for Submission of Bids .....	10
17. Opening and Preliminary Examination of Bids .....	11
18. Domestic Preference .....	11
19. Detailed Evaluation and Comparison of Bids .....	11
20. Post-Qualification .....	11
21. Signing of the Contract .....	11
<b>Section III. Bid Data Sheet .....</b>	<b>12</b>
<b>Section IV. General Conditions of Contract.....</b>	<b>13</b>
1. Scope of Contract .....	13
2. Advance Payment and Terms of Payment .....	13
3. Performance Security .....	13
4. Inspection and Tests .....	13
5. Warranty .....	13
6. Liability of the Supplier .....	14
<b>Section V. Special Conditions of Contract .....</b>	<b>15-17</b>
<b>Section VI. Schedule of Requirements .....</b>	<b>18</b>
<b>Section VII. Technical Specifications .....</b>	<b>19-28</b>
<b>Section VIII. Checklist of Technical and Financial Documents, Bid Form, Price Schedule, Performance Securing Declaration, Omnibus Sworn Statement, Bid Securing Declaration and Contract Agreement Form..</b>	<b>29-40</b>

# *Glossary of Acronyms, Terms, and Abbreviations*

**ABC** – Approved Budget for the Contract.

**BAC** – Bids and Awards Committee.

**Bid** – A signed offer or proposal to undertake a contract submitted by a bidder in response to and in consonance with the requirements of the bidding documents. Also referred to as *Proposal* and *Tender*. (2016 revised IRR, Section 5[c])

**Bidder** – Refers to a contractor, manufacturer, supplier, distributor and/or consultant who submits a bid in response to the requirements of the Bidding Documents. (2016 revised IRR, Section 5[d])

**Bidding Documents** – The documents issued by the Procuring Entity as the bases for bids, furnishing all information necessary for a prospective bidder to prepare a bid for the Goods, Infrastructure Projects, and/or Consulting Services required by the Procuring Entity. (2016 revised IRR, Section 5[e])

**BIR** – Bureau of Internal Revenue.

**BSP** – Bangko Sentral ng Pilipinas.

**Consulting Services** – Refer to services for Infrastructure Projects and other types of projects or activities of the GOP requiring adequate external technical and professional expertise that are beyond the capability and/or capacity of the GOP to undertake such as, but not limited to: (i) advisory and review services; (ii) pre-investment or feasibility studies; (iii) design; (iv) construction supervision; (v) management and related services; and (vi) other technical services or special studies. (2016 revised IRR, Section 5[i])

**CDA** - Cooperative Development Authority.

**Contract** – Refers to the agreement entered into between the Procuring Entity and the Supplier or Manufacturer or Distributor or Service Provider for procurement of Goods and Services; Contractor for Procurement of Infrastructure Projects; or Consultant or Consulting Firm for Procurement of Consulting Services; as the case may be, as recorded in the Contract Form signed by the parties, including all attachments and appendices thereto and all documents incorporated by reference therein.

**CIF** – Cost Insurance and Freight.

**CIP** – Carriage and Insurance Paid.

**CPI** – Consumer Price Index.

**DDP** – Refers to the quoted price of the Goods, which means “delivered duty paid.”

**DTI** – Department of Trade and Industry.

**EXW** – Ex works.

**FCA** – “Free Carrier” shipping point.

**FOB** – “Free on Board” shipping point.

**Foreign-funded Procurement or Foreign-Assisted Project** – Refers to procurement whose funding source is from a foreign government, foreign or international financing institution as specified in the Treaty or International or Executive Agreement. (2016 revised IRR, Section 5[b]).

**Framework Agreement** – Refers to a written agreement between a procuring entity and a supplier or service provider that identifies the terms and conditions, under which specific purchases, otherwise known as “Call-Offs,” are made for the duration of the agreement. It is in the nature of an option contract between the procuring entity and the bidder(s) granting the procuring entity the option to either place an order for any of the goods or services identified in the Framework Agreement List or not buy at all, within a minimum period of one (1) year to a maximum period of three (3) years. (GPPB Resolution No. 27-2019)

**GFI** – Government Financial Institution.

**GOCC** – Government-owned and/or –controlled corporation.

**Goods** – Refer to all items, supplies, materials and general support services, except Consulting Services and Infrastructure Projects, which may be needed in the transaction of public businesses or in the pursuit of any government undertaking, project or activity, whether in the nature of equipment, furniture, stationery, materials for construction, or personal property of any kind, including non-personal or contractual services such as the repair and maintenance of equipment and furniture, as well as trucking, hauling, janitorial, security, and related or analogous services, as well as procurement of materials and supplies provided by the Procuring Entity for such services. The term “related” or “analogous services” shall include, but is not limited to, lease or purchase of office space, media advertisements, health maintenance services, and other services essential to the operation of the Procuring Entity. (2016 revised IRR, Section 5[r])

**GOP** – Government of the Philippines.

**GPPB** – Government Procurement Policy Board.

**INCOTERMS** – International Commercial Terms.

**Infrastructure Projects** – Include the construction, improvement, rehabilitation, demolition, repair, restoration or maintenance of roads and bridges, railways, airports, seaports, communication facilities, civil works components of information technology projects, irrigation, flood control and drainage, water supply, sanitation, sewerage and solid waste management systems, shore protection, energy/power and electrification facilities, national buildings, school buildings, hospital buildings, and other related construction projects of the government. Also referred to as *civil works or works*. (2016 revised IRR, Section 5[u])

**LGUs** – Local Government Units.

**NFCC** – Net Financial Contracting Capacity.

**NGA** – National Government Agency.

**PhilGEPS** - Philippine Government Electronic Procurement System.

**Procurement Project** – refers to a specific or identified procurement covering goods, infrastructure project or consulting services. A Procurement Project shall be described, detailed, and scheduled in the Project Procurement Management Plan prepared by the agency which shall be consolidated in the procuring entity's Annual Procurement Plan. (GPPB Circular No. 06-2019 dated 17 July 2019)

**PSA** – Philippine Statistics Authority.

**SEC** – Securities and Exchange Commission.

**SLCC** – Single Largest Completed Contract.

**Supplier** – refers to a citizen, or any corporate body or commercial company duly organized and registered under the laws where it is established, habitually established in business and engaged in the manufacture or sale of the merchandise or performance of the general services covered by his bid. (Item 3.8 of GPPB Resolution No. 13-2019, dated 23 May 2019). Supplier as used in these Bidding Documents may likewise refer to a distributor, manufacturer, contractor, or consultant.

**UN** – United Nations.



# West Visayas State University

(Formerly Iloilo Normal School)

Procurement Division

Luna St., La Paz, Iloilo City 5000

Iloilo, Philippines

\* Trunkline: (063) (033) 320-0870 loc. 1103/1104 \* Telefax No.: (033) 320-0879

\* Website: [www.wvsu.edu.ph](http://www.wvsu.edu.ph) \* Email Address: [govtproc@wvsu.edu.ph](mailto:govtproc@wvsu.edu.ph)



## INVITATION TO BID FOR

### PROCUREMENT OF VARIOUS FURNITURE AND FIXTURES FOR VARIOUS OFFICES - IB NO. 2024-30

1. The West Visayas State University, through the General Appropriations Act (GAA) 2024, Special Trust Fund 2024 and Special Trust Fund (Unexpended Balances of 2023) intends to apply the sum of **Two Million Two Hundred Fifty-Nine Thousand Six Hundred Ninety-Nine Pesos (Php2,259,699.00) Only** being the ABC to payments under the contract for Procurement of Various Furniture and Fixtures for Various Offices. Bids received in excess of the ABC of per item shall be automatically rejected at bid opening.

Item No.	Description	Qty./ Unit	Unit Cost	Total Cost
1.	Computer Table	25 units	8,000.00	200,000.00
2.	Executive Desk	1 unit	26,000.00	26,000.00
3.	Executive Office Table	11 units	15,000.00	165,000.00
4.	Full Fabric Partition Panel with door	1 lot	280,000.00	280,000.00
5.	Low Office Cabinet	3 units	10,333.00	30,999.00
6.	Office Table	1 unit	11,500.00	11,500.00
7.	Office/ Computer Table	6 units	8,000.00	48,000.00
8.	Set Bar Table with 4 Chairs	6 units	20,000.00	120,000.00
9.	Single Sofa	4 units	15,000.00	60,000.00
10.	Sofa, 3-seater	3 units	25,000.00	75,000.00
11.	Step Ladder (Foldable)	4 units	10,000.00	40,000.00
12.	Teacher's Table (Workstation)	53 units	12,800.00	678,400.00
13.	Theater Seat with Arm Rest	25 units	10,000.00	250,000.00
14.	Vertical Filing Cabinet (Glass Door) 1	8 units	18,500.00	148,000.00
15.	Vertical Filing Cabinet (Glass Door) 2	2 units	18,400.00	36,800.00
16.	Vertical Filing Cabinet 1	4 units	10,000.00	40,000.00
17.	Vertical Filing Cabinet 2	5 units	10,000.00	50,000.00
	---Nothing Follows----			
	<b>GRAND TOTAL</b>			<b>Php2,259,699.00</b>

2. The West Visayas State University now invites bids for the above Procurement Project. Delivery of the Goods is required by **45 calendar days**. Bidders should have completed, within **2 years** from the date of submission and receipt of bids, a contract similar to the Project. The description of an eligible bidder is contained in the Bidding Documents, particularly, in Section II (Instructions to Bidders).
3. Bidding will be conducted through open competitive bidding procedures using a non-discretionary “pass/fail” criterion as specified in the 2016 revised Implementing Rules and Regulations (IRR) of Republic Act (RA) No. 9184.
- Bidding is restricted to Filipino citizens/sole proprietorships, partnerships, or organizations with at least sixty percent (60%) interest or outstanding capital stock belonging to citizens of the Philippines, and to citizens or organizations of a country the laws or regulations of which grant similar rights or privileges to Filipino citizens, pursuant to RA No. 5183.
4. Prospective Bidders may obtain further information from West Visayas State University, BAC Secretariat Office, Administration Building, and inspect the Bidding Documents at the address given below during **8:00 A.M. – 5:00 P.M.**

5. A complete set of Bidding Documents may be acquired by interested Bidders on **July 01 – 22, 2024** from the given address and website(s) below *and upon payment of the applicable fee for the Bidding Documents, pursuant to the latest Guidelines issued by the GPPB, in the amount of **PhP5,000.00***. The Procuring Entity shall allow the bidder to present its proof of payment for the fees *in person, by facsimile, or through electronic means*.
6. The **West Visayas State University** will hold a Pre-Bid Conference<sup>1</sup> on **July 09, 2024; 2:00 P.M.** through video conferencing or webcasting via **zoom meeting platform (for registration of interested bidders, please send your request to this address: [govtproc@wvsu.edu.ph](mailto:govtproc@wvsu.edu.ph))**, which shall be open to prospective bidders.
7. Bids must be duly received by the BAC Secretariat through (i) **manual submission at the office address indicated below**, (ii) **online or electronic submission as indicated below**, or (iii) **both** on or before **July 22, 2024; 2:00 P.M.** Late bids shall not be accepted.
8. All Bids must be accompanied by a bid security in any of the acceptable forms and in the amount stated in **ITB** Clause 14.
9. Bid opening shall be on **July 22, 2024; 2:00 P.M.** at the given **address below or through electronic submission using a two-factor security procedure consisting of an archive format compression and password protection with separate password for technical and financial component envelope**. Bids will be opened in the presence of the bidders' representatives who choose to attend the activity.
10. Requiring the Bidders to submit their bids using a two-factor security procedure consisting of an archive format compression and password protection with separate password for technical and financial component envelope and disclose the password for accessing their respective bid submission only during the actual bid opening.
11. The **West Visayas State University** reserves the right to reject any and all bids, declare a failure of bidding, or not award the contract at any time prior to contract award in accordance with Sections 35.6 and 41 of the 2016 revised IRR of RA No. 9184, without thereby incurring any liability to the affected bidder or bidders.
12. For further information, please refer to:  
  
***ROSALIE C. QUICOY***  
***Head, BAC Secretariat***  
***West Visayas State University***  
***BAC Secretariat Office, Administration Building***  
***Luna St., La Paz, Iloilo City, 5000***  
***[govtproc@wvsu.edu.ph](mailto:govtproc@wvsu.edu.ph)***  
***(033) 320-08-70-78 local 1103***  
***[wvsu.edu.ph](http://wvsu.edu.ph)***
13. You may visit the following websites:  
For downloading of Bidding Documents: **[wvsu.edu.ph](http://wvsu.edu.ph)**  
For online bid submission: **[govtproc@wvsu.edu.ph](mailto:govtproc@wvsu.edu.ph)**

***July 01, 2024***

**JULIUS B. UNДАР**  
***BAC, Chairperson***

---

<sup>1</sup> May be deleted in case the ABC is less than One Million Pesos (PhP1,000,000) where the Procuring Entity may not hold a Pre-Bid Conference.

# ***Section II. Instructions to Bidders***

## **1. Scope of Bid**

The Procuring Entity, West Visayas State University wishes to receive Bids for the Procurement of Various Furniture and Fixtures for Various Offices, with identification number IB No. 2024-30.

The Procurement Project (referred to herein as “Project”) is composed of Various Furniture and Fixtures the details of which are described in Section VII (Technical Specifications).

## **2. Funding Information**

2.1. The GOP through the source of funding as indicated below for General Appropriations Act (GAA) 2024, Special Trust Fund 2024 and Special Trust Fund (Unexpended Balances of 2023) in the amount of Two Million Two Hundred Fifty-Nine Thousand Six Hundred Ninety-Nine Pesos (Php2,259,699.00) Only.

2.2. The source of funding is:

a. NGA, General Appropriations Act (GAA) 2024, Special Trust Fund 2024 and Special Trust Fund (Unexpended Balances of 2023).

## **3. Bidding Requirements**

The Bidding for the Project shall be governed by all the provisions of RA No. 9184 and its 2016 revised IRR, including its Generic Procurement Manuals and associated policies, rules and regulations as the primary source thereof, while the herein clauses shall serve as the secondary source thereof.

Any amendments made to the IRR and other GPPB issuances shall be applicable only to the ongoing posting, advertisement, or **IB** by the BAC through the issuance of a supplemental or bid bulletin.

The Bidder, by the act of submitting its Bid, shall be deemed to have verified and accepted the general requirements of this Project, including other factors that may affect the cost, duration and execution or implementation of the contract, project, or work and examine all instructions, forms, terms, and project requirements in the Bidding Documents.

## **4. Corrupt, Fraudulent, Collusive, and Coercive Practices**

The Procuring Entity, as well as the Bidders and Suppliers, shall observe the highest standard of ethics during the procurement and execution of the contract. They or through an agent shall not engage in corrupt, fraudulent, collusive, coercive, and obstructive practices defined under Annex “I” of the 2016 revised IRR of RA No. 9184 or other integrity violations in competing for the Project.

## **5. Eligible Bidders**

5.1. Only Bids of Bidders found to be legally, technically, and financially capable will be evaluated.

5.2. Foreign ownership limited to those allowed under the rules may participate in this Project.



- 5.3. Pursuant to Section 23.4.1.3 of the 2016 revised IRR of RA No.9184, the Bidder shall have an SLCC that is at least one (1) contract similar to the Project the value of which, adjusted to current prices using the PSA's CPI, must be at least equivalent to:
- a. For the procurement of Non-expendable Supplies and Services: The Bidder must have completed a single contract that is similar to this Project, equivalent to at least fifty percent (50%) of the ABC.
  - b. For the procurement of Expendable Supplies: The Bidder must have completed a single contract that is similar to this Project, equivalent to at least twenty-five percent (25%) of the ABC.
- 5.4. The Bidders shall comply with the eligibility criteria under Section 23.4.1 of the 2016 IRR of RA No. 9184.

## 6. Origin of Goods

There is no restriction on the origin of goods other than those prohibited by a decision of the UN Security Council taken under Chapter VII of the Charter of the UN, subject to Domestic Preference requirements under **ITB** Clause 18.

## 7. Subcontracts

- 7.1. The Bidder may subcontract portions of the Project to the extent allowed by the Procuring Entity as stated herein, but in no case more than twenty percent (20%) of the Project.

The Procuring Entity has prescribed that:

- a. Subcontracting is not allowed.
- 7.2. *Not applicable*
- 7.3. *Not applicable*
- 7.4. Subcontracting of any portion of the Project does not relieve the Contractor of any liability or obligation under the Contract. The Supplier will be responsible for the acts, defaults, and negligence of any subcontractor, its agents, servants, or workmen as fully as if these were the Contractor's own acts, defaults, or negligence, or those of its agents, servants, or workmen.

## 8. Pre-Bid Conference

The Procuring Entity will hold a pre-bid conference for this Project on the specified date and time through videoconferencing/webcasting *via google meeting platform* *(for registration of interested bidders, please send your request to this address: govtproc@wvsu.edu.ph)* as indicated in paragraph 6 of the **IB**.

## 9. Clarification and Amendment of Bidding Documents

Prospective bidders may request for clarification on and/or interpretation of any part of the Bidding Documents. Such requests must be in writing and received by the Procuring Entity, either at its given address or through electronic mail indicated in the **IB**, at least ten (10) calendar days before the deadline set for the submission and receipt of Bids.

## 10. Documents comprising the Bid: Eligibility and Technical Components

- 10.1. The first envelope shall contain the eligibility and technical documents of the Bid as specified in **Section VIII (Checklist of Technical and Financial Documents)**.
- 10.2. The Bidder's SLCC as indicated in **ITB** Clause 5.3 should have been completed within 2 years prior to the deadline for the submission and receipt of bids.
- 10.3. If the eligibility requirements or statements, the bids, and all other documents for submission to the BAC are in foreign language other than English, it must be accompanied by a translation in English, which shall be authenticated by the appropriate Philippine foreign service establishment, post, or the equivalent office having jurisdiction over the foreign bidder's affairs in the Philippines. Similar to the required authentication above, for Contracting Parties to the Apostille Convention, only the translated documents shall be authenticated through an apostille pursuant to GPPB Resolution No. 13-2019 dated 23 May 2019. The English translation shall govern, for purposes of interpretation of the bid.

## 11. Documents comprising the Bid: Financial Component

- 11.1. The second bid envelope shall contain the financial documents for the Bid as specified in **Section VIII (Checklist of Technical and Financial Documents)**.
- 11.2. If the Bidder claims preference as a Domestic Bidder or Domestic Entity, a certification issued by DTI shall be provided by the Bidder in accordance with Section 43.1.3 of the 2016 revised IRR of RA No. 9184.
- 11.3. Any bid exceeding the ABC indicated in paragraph 1 of the **IB** shall not be accepted.
- 11.4. For Foreign-funded Procurement, a ceiling may be applied to bid prices provided the conditions are met under Section 31.2 of the 2016 revised IRR of RA No. 9184.

## 12. Bid Prices

- 12.1. Prices indicated on the Price Schedule shall be entered separately in the following manner:
  - a. For Goods offered from within the Procuring Entity's country:
    - i. The price of the Goods quoted EXW (ex-works, ex-factory, ex-warehouse, ex-showroom, or off-the-shelf, as applicable);
    - ii. The cost of all customs duties and sales and other taxes already paid or payable;
    - iii. The cost of transportation, insurance, and other costs incidental to delivery of the Goods to their final destination; and
    - iv. The price of other (incidental) services, if any, listed in e.
  - b. For Goods offered from abroad:

- i. Unless otherwise stated in the **BDS**, the price of the Goods shall be quoted delivered duty paid (DDP) with the place of destination in the Philippines as specified in the **BDS**. In quoting the price, the Bidder shall be free to use transportation through carriers registered in any eligible country. Similarly, the Bidder may obtain insurance services from any eligible source country.
- ii. The price of other (incidental) services, if any, as listed in **Section VII (Technical Specifications)**.

### **13. Bid and Payment Currencies**

13.1. For Goods that the Bidder will supply from outside the Philippines, the bid prices may be quoted in the local currency or tradeable currency accepted by the BSP at the discretion of the Bidder. However, for purposes of bid evaluation, Bids denominated in foreign currencies, shall be converted to Philippine currency based on the exchange rate as published in the BSP reference rate bulletin on the day of the bid opening.

13.2. Payment of the contract price shall be made in:

- a. Philippine Pesos.

### **14. Bid Security**

14.1. The Bidder shall submit a Bid Securing Declaration<sup>2</sup> or any form of Bid Security in the amount indicated in the **BDS**, which shall be not less than the percentage of the ABC in accordance with the schedule in the **BDS**.

14.2. The Bid and bid security shall be valid until **November 19, 2024**. Any Bid not accompanied by an acceptable bid security shall be rejected by the Procuring Entity as non-responsive.

### **15. Sealing and Marking of Bids**

Each Bidder shall submit one copy of the first and second components of its Bid.

The Procuring Entity may request additional hard copies and/or electronic copies of the Bid. However, failure of the Bidders to comply with the said request shall not be a ground for disqualification.

If the Procuring Entity allows the submission of bids through online submission or any other electronic means, the Bidder shall submit an electronic copy of its Bid, which must be digitally signed. An electronic copy that cannot be opened or is corrupted shall be considered non-responsive and, thus, automatically disqualified.

### **16. Deadline for Submission of Bids**

16.1. The Bidders shall submit on the specified date and time and either at its physical address or through online submission as indicated in paragraph 7 of the **IB**.

### **17. Opening and Preliminary Examination of Bids**

17.1. The BAC shall open the Bids in public at the time, on the date, and at the place specified in paragraph 9 of the **IB**. The Bidders' representatives who are present shall sign a register evidencing their attendance. In case

---

<sup>2</sup> In the case of Framework Agreement, the undertaking shall refer to entering into contract with the Procuring Entity and furnishing of the performance security or the performance securing declaration within ten (10) calendar days from receipt of Notice to Execute Framework Agreement.

videoconferencing, webcasting or other similar technologies will be used, attendance of participants shall likewise be recorded by the BAC Secretariat.

In case the Bids cannot be opened as scheduled due to justifiable reasons, the rescheduling requirements under Section 29 of the 2016 revised IRR of RA No. 9184 shall prevail.

- 17.2. The preliminary examination of bids shall be governed by Section 30 of the 2016 revised IRR of RA No. 9184.

## **18. Domestic Preference**

- 18.1. The Procuring Entity will grant a margin of preference for the purpose of comparison of Bids in accordance with Section 43.1.2 of the 2016 revised IRR of RA No. 9184.

## **19. Detailed Evaluation and Comparison of Bids**

- 19.1. The Procuring BAC shall immediately conduct a detailed evaluation of all Bids rated "*passed*," using non-discretionary pass/fail criteria. The BAC shall consider the conditions in the evaluation of Bids under Section 32.2 of the 2016 revised IRR of RA No. 9184.
- 19.2. If the Project allows partial bids, bidders may submit a proposal on any of the lots or items, and evaluation will be undertaken on a per lot or item basis, as the case maybe. In this case, the Bid Security as required by ITB Clause 15 shall be submitted for each lot or item separately.
- 19.3. The descriptions of the lots or items shall be indicated in **Section VII (Technical Specifications)**, although the ABCs of these lots or items are indicated in the **BDS** for purposes of the NFCC computation pursuant to Section 23.4.2.6 of the 2016 revised IRR of RA No. 9184. The NFCC must be sufficient for the total of the ABCs for all the lots or items participated in by the prospective Bidder.
- 19.4. The Project shall be awarded as follows:  
**One Project having several items, which shall be awarded as separate contracts per item.**
- 19.5. Except for bidders submitting a committed Line of Credit from a Universal or Commercial Bank in lieu of its NFCC computation, all Bids must include the NFCC computation pursuant to Section 23.4.1.4 of the 2016 revised IRR of RA No. 9184, which must be sufficient for the total of the ABCs for all the lots or items participated in by the prospective Bidder. For bidders submitting the committed Line of Credit, it must be at least equal to ten percent (10%) of the ABCs for all the lots or items participated in by the prospective Bidder.

## **20. Post-Qualification**

- 20.1. Within a non-extendible period of five (5) calendar days from receipt by the Bidder of the notice from the BAC that it submitted the Lowest Calculated Bid, the Bidder shall submit its latest income and business tax returns filed and paid through the BIR Electronic Filing and Payment System (eFPS) and other appropriate licenses and permits required by law and stated in the **BDS**.

## **21. Signing of the Contract**

- 21.1. The documents required in Section 37.2 of the 2016 revised IRR of RA No. 9184 shall form part of the Contract. Additional Contract documents are indicated in the **BDS**.

## *Section III. Bid Data Sheet*

<b>ITB Clause</b>	
5.3	For this purpose, contracts similar to the Project shall be: <ul style="list-style-type: none"> <li>a. <b><u>Procurement of Various Furniture and Fixtures or equivalent thereof.</u></b></li> <li>b. Completed within <b><u>2 years</u></b> prior to the deadline for the submission and receipt of bids.</li> </ul>
7.1	<i>N/A</i>
12	The price of the Goods shall be quoted DDP <b><u>in Philippines</u></b> or the applicable International Commercial Terms (INCOTERMS) for this Project.
14.1	The bid security shall be in the form of a Bid Securing Declaration, or any of the following forms and amounts: <ul style="list-style-type: none"> <li>a. The amount of not less than <b><u>Php45,193.98</u></b> equivalent to two percent (2%) of ABC], if bid security is in cash, cashier's/manager's check, bank draft/guarantee or irrevocable letter of credit; or</li> <li>b. The amount of not less than <b><u>Php112,984.95</u></b> equivalent to five percent (5%) of ABC] if bid security is in Surety Bond.</li> </ul>
19.3	<b><u>Procurement of Various Furniture and Fixtures for Various Offices – Php2,259,699.00.</u></b>
20.1	<b><u>Latest income and business tax returns filed and paid through the BIR Electronic Filing and Payment System (eFPS).</u></b>
21.2	<b><u>Certificate of Warranty to include a statement specifying the service response period which shall not be later than five (5) days from receipt of notice/complaint from the Project Management Office (PMO)/Technical Working Group (TWG)/ End-user.</u></b>

# ***Section IV. General Conditions of Contract***

## **1. Scope of Contract**

This Contract shall include all such items, although not specifically mentioned, that can be reasonably inferred as being required for its completion as if such items were expressly mentioned herein. All the provisions of RA No. 9184 and its 2016 revised IRR, including the Generic Procurement Manual, and associated issuances, constitute the primary source for the terms and conditions of the Contract, and thus, applicable in contract implementation. Herein clauses shall serve as the secondary source for the terms and conditions of the Contract.

This is without prejudice to Sections 74.1 and 74.2 of the 2016 revised IRR of RA No. 9184 allowing the GPPB to amend the IRR, which shall be applied to all procurement activities, the advertisement, posting, or invitation of which were issued after the effectivity of the said amendment.

Additional requirements for the completion of this Contract shall be provided in the **Special Conditions of Contract (SCC)**.

## **2. Advance Payment and Terms of Payment**

2.1. Advance payment of the contract amount is provided under Annex “D” of the revised 2016 IRR of RA No. 9184.

2.2. The Procuring Entity is allowed to determine the terms of payment on the partial or staggered delivery of the Goods procured, provided such partial payment shall correspond to the value of the goods delivered and accepted in accordance with prevailing accounting and auditing rules and regulations. The terms of payment are indicated in the SCC.

## **3. Performance Security**

Within ten (10) calendar days from receipt of the Notice of Award by the Bidder from the Procuring Entity but in no case later than prior to the signing of the Contract by both parties, the successful Bidder shall furnish the performance security in any of the forms prescribed in Section 39 of the 2016 revised IRR of RA No. 9184.

## **4. Inspection and Tests**

The Procuring Entity or its representative shall have the right to inspect and/or to test the Goods to confirm their conformity to the Project. In addition to tests in the **SCC, Section IV (Technical Specifications)** shall specify what inspections and/or tests the Procuring Entity requires, and where they are to be conducted. The Procuring Entity shall notify the Supplier in writing, in a timely manner, of the identity of any representatives retained for these purposes.

All reasonable facilities and assistance for the inspection and testing of Goods, including access to drawings and production data, shall be provided by the Supplier to the authorized inspectors at no charge to the Procuring Entity.

## **5. Warranty**

6.1. In order to assure that manufacturing defects shall be corrected by the Supplier, a warranty shall be required from the Supplier as provided under Section 62.1 of the 2016 revised IRR of RA No. 9184.

6.2. The Procuring Entity shall promptly notify the Supplier in writing of any claims arising under this warranty. Upon receipt of such notice, the Supplier shall, repair or replace the defective Goods or parts thereof without cost to the Procuring Entity, pursuant to the Generic Procurement Manual.

## **6. Liability of the Supplier**

The Supplier's liability under this Contract shall be as provided by the laws of the Republic of the Philippines.

If the Supplier is a joint venture, all partners to the joint venture shall be jointly and severally liable to the Procuring Entity.



# *Section V. Special Conditions of Contract*

## **Special Conditions of Contract**

GCC Clause	
1	<p><b>Delivery and Documents –</b></p> <p>For purposes of the Contract, “EXW,” “FOB,” “FCA,” “CIF,” “CIP,” “DDP” and other trade terms used to describe the obligations of the parties shall have the meanings assigned to them by the current edition of INCOTERMS published by the International Chamber of Commerce, Paris. The Delivery terms of this Contract shall be as follows:</p> <p><i>For Goods supplied from abroad, “The delivery terms applicable to the Contract are DDP delivered <b><u>West Visayas State University, Luna St., La Paz, Iloilo City.</u></b> In accordance with INCOTERMS.”</i></p> <p><i>For Goods supplied from within the Philippines, “The delivery terms applicable to this Contract are delivered <b><u>West Visayas State University, Luna St., La Paz, Iloilo City.</u></b> Risk and title will pass from the Supplier to the Procuring Entity upon receipt and final acceptance of the Goods at their final destination.”</i></p> <p>Delivery of the Goods shall be made by the Supplier in accordance with the terms specified in Section VI (Schedule of Requirements).</p> <p>For purposes of this Clause the Procuring Entity’s Representative at the Project Site is <b><u>Mr. Julius B. Undar – Chief Administrative Officer and Ar. Gerard L. Ibañez – TWG, Furniture and Fixtures.</u></b></p> <p><b>Incidental Services –</b> The Supplier is required to provide all of the following services, including additional services, if any, specified in Section VI. Schedule of Requirements: <i>Select appropriate requirements and delete the rest.</i></p> <ol style="list-style-type: none"> <li>a. performance or supervision of on-site assembly and/or start-up of the supplied Goods;</li> <li>b. furnishing of tools required for assembly and/or maintenance of the supplied Goods;</li> <li>c. furnishing of a detailed operations and maintenance manual for each appropriate unit of the supplied Goods;</li> <li>d. performance or supervision or maintenance and/or repair of the supplied Goods, for a period of time agreed by the parties, provided that this service shall not relieve the Supplier of any warranty obligations under this Contract; and</li> </ol> <ol style="list-style-type: none"> <li>e. training of the Procuring Entity’s personnel, at the Supplier’s plant and/or on-site, in assembly, start-up, operation, maintenance, and/or repair of the supplied Goods.</li> <li>f. <i>Specify additional incidental service requirements, as needed. None</i></li> </ol> <p>The Contract price for the Goods shall include the prices charged by the Supplier for incidental services and shall not exceed the prevailing rates charged to other parties by the Supplier for similar services.</p>



	<p><b>Packaging –</b></p> <p>The Supplier shall provide such packaging of the Goods as is required to prevent their damage or deterioration during transit to their final destination, as indicated in this Contract. The packaging shall be sufficient to withstand, without limitation, rough handling during transit and exposure to extreme temperatures, salt and precipitation during transit, and open storage. Packaging case size and weights shall take into consideration, where appropriate, the remoteness of the Goods’ final destination and the absence of heavy handling facilities at all points in transit.</p> <p>The packaging, marking, and documentation within and outside the packages shall comply strictly with such special requirements as shall be expressly provided for in the Contract, including additional requirements, if any, specified below, and in any subsequent instructions ordered by the Procuring Entity.</p> <p>The outer packaging must be clearly marked on at least four (4) sides as follows:</p> <p>Name of the Procuring Entity  Name of the Supplier  Contract Description</p>
	<p>Final Destination  Gross weight  Any special lifting instructions  Any special handling instructions  Any relevant HAZCHEM classifications</p>
	<p>A packaging list identifying the contents and quantities of the package is to be placed on an accessible point of the outer packaging if practical. If not practical the packaging list is to be placed inside the outer packaging but outside the secondary packaging.</p> <p><b>Transportation –</b></p> <p>Where the Supplier is required under Contract to deliver the Goods CIF, CIP, or DDP, transport of the Goods to the port of destination or such other named place of destination in the Philippines, as shall be specified in this Contract, shall be arranged and paid for by the Supplier, and the cost thereof shall be included in the Contract Price.</p> <p>Where the Supplier is required under this Contract to transport the Goods to a specified place of destination within the Philippines, defined as the Project Site, transport to such place of destination in the Philippines, including insurance and storage, as shall be specified in this Contract, shall be arranged by the Supplier, and related costs shall be included in the contract price.</p>
	<p>Where the Supplier is required under Contract to deliver the Goods CIF, CIP or DDP, Goods are to be transported on carriers of Philippine registry. In the event that no carrier of Philippine registry is available, Goods may be shipped by a carrier which is not of Philippine registry provided that the Supplier obtains and presents to the Procuring Entity certification to this effect from the nearest Philippine consulate to the port of dispatch. In the event that carriers of Philippine registry are available but their schedule delays the Supplier in its performance of this Contract the period from when the Goods were first ready for shipment and the actual date of shipment the period of delay will be considered force majeure.</p>

	<p>The Procuring Entity accepts no liability for the damage of Goods during transit other than those prescribed by INCOTERMS for DDP deliveries. In the case of Goods supplied from within the Philippines or supplied by domestic Suppliers risk and title will not be deemed to have passed to the Procuring Entity until their receipt and final acceptance at the final destination.</p> <p><b>Intellectual Property Rights –</b></p> <p>The Supplier shall indemnify the Procuring Entity against all third-party claims of infringement of patent, trademark, or industrial design rights arising from use of the Goods or any part thereof.</p>
2.2	<i>[If partial payment is allowed, state]</i> “The terms of payment shall be as follows: <b><u>not applicable.</u></b> ”
4	The inspections and tests that will be conducted are: <b><u>Performance and Functionality Test.</u></b>

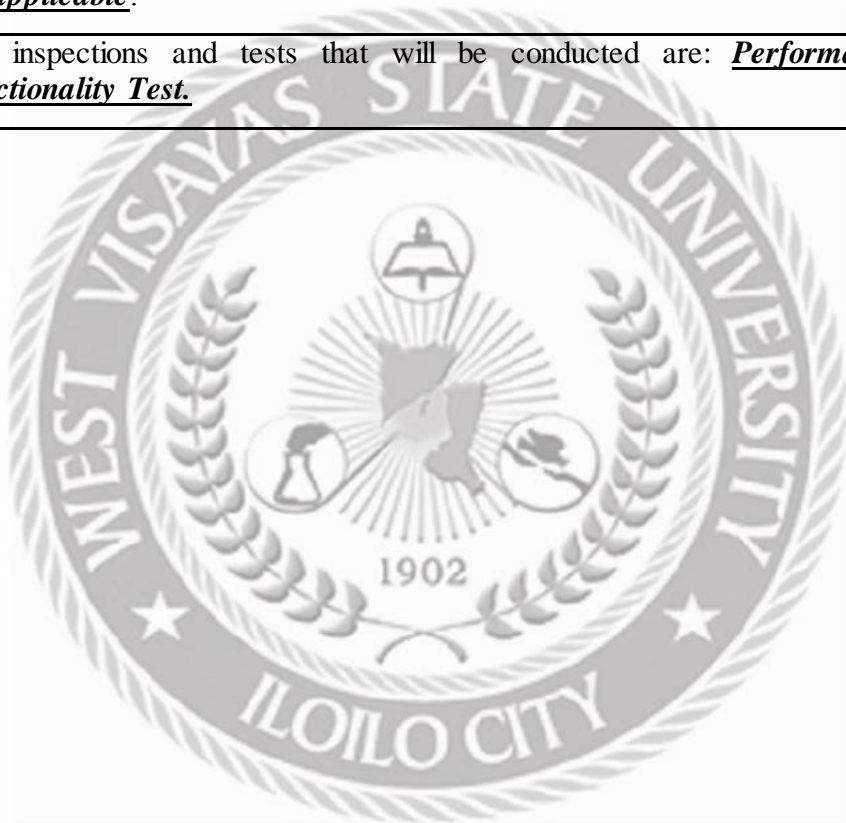

## ***Section VI. Schedule of Requirements***

The delivery schedule expressed as weeks/months stipulates hereafter a delivery date which is the date of delivery to the project site.

<b>Item Number</b>	<b>Description</b>	<b>Quantity</b>	<b>Total</b>	<b>Delivered, Weeks/Months</b>
1.	<i>Computer Table</i>	<i>25 units</i>		
2.	<i>Executive Desk</i>	<i>1 unit</i>		
3.	<i>Executive Office Table</i>	<i>11 units</i>		
4.	<i>Full Fabric Partition Panel with door</i>	<i>1 lot</i>		
5.	<i>Low Office Cabinet</i>	<i>3 units</i>		
6.	<i>Office Table</i>	<i>1 unit</i>		
7.	<i>Office/ Computer Table</i>	<i>6 units</i>		
8.	<i>Set Bar Table with 4 Chairs</i>	<i>6 units</i>		
9.	<i>Single Sofa</i>	<i>4 units</i>		
10.	<i>Sofa, 3-seater</i>	<i>3 units</i>		
11.	<i>Step Ladder (Foldable)</i>	<i>4 units</i>		
12.	<i>Teacher's Table (Workstation)</i>	<i>53 units</i>		
13.	<i>Theater Seat with Arm Rest</i>	<i>25 units</i>		
14.	<i>Vertical Filing Cabinet (Glass Door) 1</i>	<i>8 units</i>		
15.	<i>Vertical Filing Cabinet (Glass Door) 2</i>	<i>2 units</i>		
16.	<i>Vertical Filing Cabinet 1</i>	<i>4 units</i>		
17.	<i>Vertical Filing Cabinet 2</i>	<i>5 units</i>		
	<i>----Nothing Follows-----</i>			

Name of Bidder: \_\_\_\_\_

Submitted by: \_\_\_\_\_  
(Printed Name and Signature)

Designation: \_\_\_\_\_

Date: \_\_\_\_\_

## Section VII. Technical Specifications

Item No.	Specification	Statement of Compliance
<b>Procurement of Various Furniture and Fixtures for Various Offices</b>		<b>Statement of Compliance</b>
1.	<b><u>COMPUTER TABLE – COMPUTER LAB.</u></b> <b>Qty/ Unit: 25 units</b> <b>Pls. specify brand and model:</b> <b>Unit Cost: 8,000.00</b> <ul style="list-style-type: none"> <li>• Table Top: 25mm melamine with grommets</li> <li>• Frame: Steel powder coated</li> <li>• Legs: with adjustable footings and with hole for wire management</li> <li>• Color: Light Gray</li> <li>• Dimension: L1.5 x W.70 x H.74m</li> <li>• Warranty: 1 year</li> </ul>	
2.	<b><u>EXECUTIVE DESK – COM (Increase in Carrying Capacity)</u></b> <b>Qty/ Unit: 1 unit</b> <b>Pls. specify brand and model:</b> <b>Unit Cost: 26,000.00</b> <ul style="list-style-type: none"> <li>• Veneer finish with writing pad</li> <li>• With side table and moveable drawer</li> <li>• Color: walnut</li> <li>• Dimension: L1.6xW.80xH.75m</li> </ul>	
3.	<b><u>EXECUTIVE OFFICE TABLE – COM (Increase in Carrying Capacity)</u></b> <b>Qty/ Unit: 11 units</b> <b>Pls. specify brand and model:</b> <b>Unit Cost: 15,000.00</b> <ul style="list-style-type: none"> <li>-with 50mm melamine top and legs</li> <li>-with center and side drawers with lock, w/ handles</li> <li>-with 1 cabinet type for CPU</li> <li>-Color: walnut</li> <li>- Dimension: 1.6x.80x.75m</li> <li>-Warranty: 1 year</li> </ul>	
4.	<b><u>FULL FABRIC PARTITION PANEL WITH DOOR - UEDC</u></b> <b>Qty/ Unit: 1 lot</b> <b>Pls. specify brand and model:</b> <b>Unit Cost: 280,000.00</b> <p><b>A. 5cm PARTITION PANEL – 5 pcs.</b></p> <ul style="list-style-type: none"> <li>• Full Fabric Partition Panel w/ wire trunking</li> <li>• Glass at 2.10m high (1.20m height)</li> <li>• With glossy coated white aluminum top &amp; side cover</li> <li>• With PVC wiring guide &amp; w/ slotted U-Bar</li> <li>• Dimension: H3.00m x W0.90m</li> <li>• Warranty: 1 year</li> </ul>	

## Section VII. Technical Specifications

Item No.	Specification	Statement of Compliance
		[Bidders must state here either "Comply" or "Not Comply" against each of the individual parameters of each Specification stating the corresponding performance parameter of the equipment offered. Statements of "Comply" or "Not Comply" must be supported by evidence in a Bidders Bid and cross-referenced to that evidence. Evidence shall be in the form of manufacturer's un-amended sales literature, unconditional statements of specification and compliance issued by the manufacturer, samples, independent test data etc., as appropriate. A statement that is not supported by evidence or is subsequently found to be contradicted by the evidence presented will render the Bid under evaluation liable for rejection. A statement either in the Bidder's statement of compliance or the supporting evidence that is found to be false either during Bid evaluation, post-qualification or the execution of the Contract may be regarded as fraudulent and render the Bidder or supplier liable for prosecution subject to the applicable laws and issuances.]
<b>Procurement of Various Furniture and Fixtures for Various Offices</b>		<b>Statement of Compliance</b>
	<b>B. 5cm PARTITION PANEL – 2 pcs.</b>	
	• Full Fabric Partition Panel w/ wire trunking	
	• With glossy coated white aluminum top & side cover	
	• w/PVC wiring guide	
	• Dimension: H3.00m x W0.60m	
	• Warranty: 1 year	
	<b>C. DOOR PARTITION – 1 pc.</b>	
	• Total Dimension: H3.00m x W0.90m	
	• Half Glass Fabric Partition Panel	
	• w/ glossy coated white aluminum top & side cover	
	• w/ dedicated glass window frame and door frame	
	• Dimension of door: H2.10 x W0.90m, with heavy duty hinges	
	• Warranty: 1 year	
	<b>D. 5cm PARTITION PANEL – 6 pcs.</b>	
	• Half Glass/ Fabric Partition Panel w/ wire trunking	
	• Glass at 2.10m high (1.20m height)	
	• w/ glossy coated white aluminum top & side cover	
	• w/PVC wiring guide & w/ slotted U-Bar	
	• Dimension: H0.60m x W0.90m	
	• Warranty: 1 year	
	<b>E. 5cm PARTITION PANEL – 2 pcs.</b>	
	• Full Fabric Partition Panel w/ wire trunking	
	• w/ glossy coated white aluminum top & side cover	
	• w/PVC wiring guide	
	• Dimension: H0.60m x W0.60m	
	• Warranty: 1 year	
<b>5.</b>	<b><u>LOW OFFICE CABINET - USAC</u></b>	
	<b>Qty/ Unit: 3 units</b>	
	<b>Pls. specify brand and model:</b>	
	<b>Unit Cost: 10,333.00</b>	
	• w/ glass sliding door with lock	
	• w/ adjustable shelf	
	• w/ powder coated steel frame	
	• Color: Light gray	
	• Dimension: L.90 x W.40 x H.90m	
	• Warranty: 1 year	
<b>6.</b>	<b><u>OFFICE TABLE - USAC</u></b>	
	<b>Qty/ Unit: 1 unit</b>	
	<b>Pls. specify brand and model:</b>	
	<b>Unit Cost: 11,500.00</b>	
	- w/ 4 fully extended drawers w/ central lock	
	- w/ metal glider, w/ plastic footings	
	- w/ full drawer height steel divider for each drawer	

## Section VII. Technical Specifications

Item No.	Specification	Statement of Compliance
		<i>[Bidders must state here either "Comply" or "Not Comply" against each of the individual parameters of each Specification stating the corresponding performance parameter of the equipment offered. Statements of "Comply" or "Not Comply" must be supported by evidence in a Bidders Bid and cross-referenced to that evidence. Evidence shall be in the form of manufacturer's un-amended sales literature, unconditional statements of specification and compliance issued by the manufacturer, samples, independent test data etc., as appropriate. A statement that is not supported by evidence or is subsequently found to be contradicted by the evidence presented will render the Bid under evaluation liable for rejection. A statement either in the Bidder's statement of compliance or the supporting evidence that is found to be false either during Bid evaluation, post-qualification or the execution of the Contract may be regarded as fraudulent and render the Bidder or supplier liable for prosecution subject to the applicable laws and issuances.]</i>
	<b>Procurement of Various Furniture and Fixtures for Various Offices</b>	<b>Statement of Compliance</b>
	- w/ integrated aluminum handle and label holder	
	- w/ anti tilt support & w/ gauge #22 powder coated steel frame	
	- Color: Light Gray	
	- Dimension: L.62 x W.45 x H1.33m	
	-Warranty: 1 year	
7.	<b><u>OFFICE/ COMPUTER TABLE - COM (Increase in Carrying Capacity)</u></b>	
	<b>Qty/ Unit: 6 units</b>	
	<b>Pls. specify brand and model:</b>	
	<b>Unit Cost: 8,000.00</b>	
	<ul style="list-style-type: none"> <li>• With 25mm melamine top</li> <li>• With keyboard drawer and side drawer</li> <li>• Color: walnut</li> <li>• Dimension: L1.0xW.50xH.75m</li> <li>• Warranty: 1 year</li> </ul>	
8.	<b><u>SET BAR TABLE with 4 CHAIRS - COM (Increase in Carrying Capacity)</u></b>	
	<b>Qty/ Unit: 6 units</b>	
	<b>Pls. specify brand and model:</b>	
	<b>Unit Cost: 20,000.00</b>	
	Round top Table with 4 chairs	
	<b>BAR TABLE</b>	
	Features: with MDF table top	
	With wooden legs	
	Color: white	
	Dimension: L.60xW.60xH1.02m	
	<b>BAR CHAIR (4 units)</b>	
	With ABS plastic and with gaslift	
	With chrome base	
	Color: white	
	<b>BAR CHAIR (20 units)</b>	
	Bar chair with wooden legs and w/ polypropylene seat.	
	Warranty: 1 year	
9.	<b><u>SINGLE SOFA - COM (Increase in Carrying Capacity)</u></b>	
	<b>Qty/ Unit: 4 units</b>	
	<b>Pls. specify brand and model:</b>	
	<b>Unit Cost: 15,000.00</b>	
	1 Seater sofa with stainless steel frame	
	Color: Black leatherette	
	Dimension: 93 x 71 x 60 cm.	
	Warranty: 1 year	

## Section VII. Technical Specifications

Item No.	Specification	Statement of Compliance
		[Bidders must state here either "Comply" or "Not Comply" against each of the individual parameters of each Specification stating the corresponding performance parameter of the equipment offered. Statements of "Comply" or "Not Comply" must be supported by evidence in a Bidders Bid and cross-referenced to that evidence. Evidence shall be in the form of manufacturer's un-amended sales literature, unconditional statements of specification and compliance issued by the manufacturer, samples, independent test data etc., as appropriate. A statement that is not supported by evidence or is subsequently found to be contradicted by the evidence presented will render the Bid under evaluation liable for rejection. A statement either in the Bidder's statement of compliance or the supporting evidence that is found to be false either during Bid evaluation, post-qualification or the execution of the Contract may be regarded as fraudulent and render the Bidder or supplier liable for prosecution subject to the applicable laws and issuances.]
<b>Procurement of Various Furniture and Fixtures for Various Offices</b>		<b>Statement of Compliance</b>
10.	<b><u>SOFA, 3-SEATER - COM (Increase in Carrying Capacity)</u></b>	
	<b>Qty/ Unit: 3 units</b>	
	<b>Pls. specify brand and model:</b>	
	<b>Unit Cost: 25,000.00</b>	
	3 Seater sofa with stainless steel frame	
	Color: black leatherette	
	Dimension: L 2.0 x W .73 x H .71 m	
	Warranty: 1 year	
11.	<b><u>STEP LADDER (FOLDABLE) - COM (Increase in Carrying Capacity)</u></b>	
	<b>Qty/ Unit: 4 units</b>	
	<b>Pls. specify brand and model:</b>	
	<b>Unit Cost: 10,000.00</b>	
	16 Step	
	Multi-Purpose Ladder (Folding)	
	Aluminum Alloy	
	Water proof, corrosion resistant, high strength, durable	
	Portable and convenient lightweight and compact size	
	Easy to transport and store	
	Heavy duty closure strap secures the ladder firmly	
	Easy to carry it with one hand	
	Warranty: 1 year	
12.	<b><u>TEACHER'S TABLE (WORKSTATION) – CON-RLE</u></b>	
	<b>Qty/ Unit: 53 units</b>	
	<b>Pls. specify brand and model:</b>	
	<b>Unit Cost: 12,800.00</b>	
	• w/ striped glass and w/2 tone melamine	
	• w/ powder coated white frame and wire trunking cover	
	• Table top: 25mm melamine with grommets	
	• L1.2 x W.60m, Color: Walnut	
	• Color: Walnut + White	
	• Dimension: L1.29 x W.645 x H1.20m	
	• Warranty: 1 year	
13.	<b><u>THEATER SEAT – COC LAB.</u></b>	
	<b>Qty/ Unit: 1 lot (5 sets for 5 seater)</b>	
	<b>Pls. specify brand and model:</b>	
	<b>Unit Cost: 250,000.00</b>	
	Theater chair with foldable tablet, fabric cushion, red color, high density injection molded plastic seat and back, shell: multi-element composite material; cloth: high grade special cloth, lining: multi-element composite material, injection molded, anti-shock and anti-distortion,	

## Section VII. Technical Specifications

Item No.	Specification	Statement of Compliance
		[Bidders must state here either "Comply" or "Not Comply" against each of the individual parameters of each Specification stating the corresponding performance parameter of the equipment offered. Statements of "Comply" or "Not Comply" must be supported by evidence in a Bidders Bid and cross-referenced to that evidence. Evidence shall be in the form of manufacturer's un-amended sales literature, unconditional statements of specification and compliance issued by the manufacturer, samples, independent test data etc., as appropriate. A statement that is not supported by evidence or is subsequently found to be contradicted by the evidence presented will render the Bid under evaluation liable for rejection. A statement either in the Bidder's statement of compliance or the supporting evidence that is found to be false either during Bid evaluation, post-qualification or the execution of the Contract may be regarded as fraudulent and render the Bidder or supplier liable for prosecution subject to the applicable laws and issuances.]
<b>Procurement of Various Furniture and Fixtures for Various Offices</b>		<b>Statement of Compliance</b>
	leg: high-quality 2mm cold-rolled high carbon steel, molded by welding; Armrest: multi- element composite material, injection molded Foot Plate/ Stand: High quality cold rolled steel, coated with epoxy paint finish. Made of high quality rectangular hollow tube of 80mm x 40mm x 1.5mm thick (minimum dimension) continuous welded to 2mm thickness (minimum) steel plate Fabric: Upholstery fabric (polyester/ hemp)	
	Dimensions:	
	585mm W (armrest center to center),	
	80mm W (armrest);	
	1000mm H (backrest),	
	610mm H (armrest),	
	450mm H (seat)	
	Armrest surface: solid wood with painting Aisle panel: Padded with foam and upholstered with fabric Writing Tablet: made of wood with laminated finished	
	Outer backrest: Injection molded high impact resistant linear polypropylene plastic	
	Cushions: High density cold-molded foam padding; comfortable human engineering design; shape is designed according to the human body; 35kg/m <sup>3</sup> minimum back and seat foam density; 100-140mm thickness	
	Warranty: 1 year	
14.	<b><u>VERTICAL FILING CABINET (GLASS DOOR) 1 – CENTRAL LAB.</u></b>	
	<b>Qty/ Unit: 8 units</b>	
	<b>Pls. specify brand and model:</b>	
	<b>Unit Cost: 18,500.00</b>	
	<ul style="list-style-type: none"> <li>• With glass swing door with lock and with four (4) adjustable shelves</li> <li>• Color: Powder coated light gray</li> <li>• Dimension: L.90 x W.45 x H1.85m</li> <li>• Gauge: #22 powder coated steel frame</li> <li>• Warranty: 1 year (for Factory Defect)</li> </ul>	
15.	<b><u>VERTICAL FILING CABINET (GLASS DOOR) 2 – UCA</u></b>	
	<b>Qty/ Unit: 2 units</b>	
	<b>Pls. specify brand and model:</b>	
	<b>Unit Cost: 18,400.00</b>	
	<ul style="list-style-type: none"> <li>• With glass swing door with lock and with four (4) adjustable shelves</li> <li>• Color: Powder coated light gray</li> <li>• Dimension: L.90 x W.45 x H1.85m</li> <li>• Gauge: #22 powder coated steel frame</li> <li>• Warranty: 1 year (for Factory Defect)</li> </ul>	



## Section VII. Technical Specifications

Item No.	Specification	Statement of Compliance
		<i>[Bidders must state here either "Comply" or "Not Comply" against each of the individual parameters of each Specification stating the corresponding performance parameter of the equipment offered. Statements of "Comply" or "Not Comply" must be supported by evidence in a Bidders Bid and cross-referenced to that evidence. Evidence shall be in the form of manufacturer's un-amended sales literature, unconditional statements of specification and compliance issued by the manufacturer, samples, independent test data etc., as appropriate. A statement that is not supported by evidence or is subsequently found to be contradicted by the evidence presented will render the Bid under evaluation liable for rejection. A statement either in the Bidder's statement of compliance or the supporting evidence that is found to be false either during Bid evaluation, post-qualification or the execution of the Contract may be regarded as fraudulent and render the Bidder or supplier liable for prosecution subject to the applicable laws and issuances.]</i>
<b>Procurement of Various Furniture and Fixtures for Various Offices</b>		<b>Statement of Compliance</b>
<b>16.</b>	<b><u>VERTICAL FILING CABINET 1 - USAC</u></b>	
	<b><i>Qty/ Unit: 4 units</i></b>	
	<b><i>Pls. specify brand and model:</i></b>	
	<b><i>Unit Cost: 10,000.00</i></b>	
	<i>- w/ 4 fully extended drawers w/ central lock</i>	
	<i>- w/ metal glider, w/ plastic footings</i>	
	<i>- w/ full drawer height steel divider for each drawer</i>	
	<i>- w/ integrated aluminum handle and label holder</i>	
	<i>- w/ anti tilt support &amp; w/ gauge #22 powder coated steel frame</i>	
	<i>- Color: Light Gray</i>	
	<i>- Dimension: L.62 x W.45 x H1.33m</i>	
	<i>-Warranty: 1 year</i>	
<b>17.</b>	<b><u>VERTICAL FILING CABINET 2-REGISTRAR</u></b>	
	<b><i>Qty/ Unit: 5 units</i></b>	
	<b><i>Pls. specify brand and model:</i></b>	
	<b><i>Unit Cost: 10,000.00</i></b>	
	<i>Size: H1330 x W454xD620mm</i>	
	<i>Weight: 36kg</i>	
	<i>Thickness: Gauge 22</i>	
	<i>3 Section Silent Slide Rail</i>	
	<i>Central lock</i>	
	<i>Powder coated steel frame</i>	
	<i>Color: Dark Green</i>	
	<i>Warranty: 1 year</i>	
	<ul style="list-style-type: none"> <li>• <b>Conditions:</b> <i>Bidders must submit/provide certificate that they have an authorized representative/branch in Iloilo City or within Western Visayas and must be engaged in Office Furnitures's and Fixtures business for the last ten (10) years. Sample of furniture's and fixtures must be readily available for inspection.</i></li> </ul>	
	<b><i>----Nothing Follows----</i></b>	

Name: \_\_\_\_\_

Legal Capacity: \_\_\_\_\_

Signature: \_\_\_\_\_

Duly authorized to sign the Bid for and behalf of: \_\_\_\_\_

**PICTURES FOR THE PROJECT:  
PROCUREMENT OF VARIOUS FURNITURE AND FIXTURES – IB NO. 2024-30**

**1. COMPUTER TABLE**

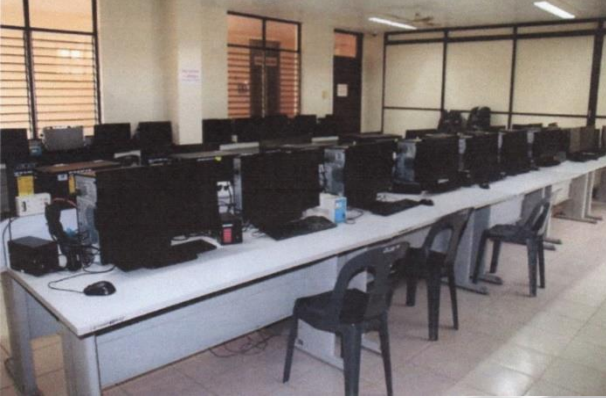

**2. EXECUTIVE DESK**



**3. EXECUTIVE OFFICE TABLE**



**4. FULL FABRIC PARTITION PANEL WITH DOOR**

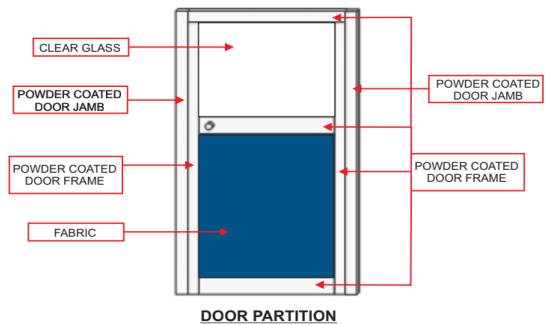
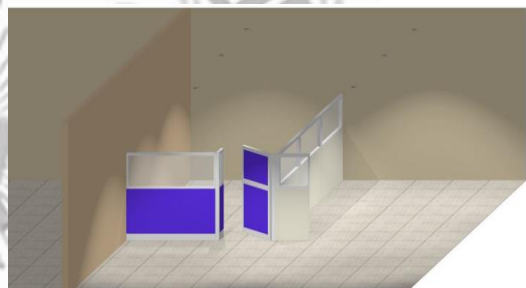

**5. LOW OFFICE CABINET**



**6. OFFICE TABLE**



**7. OFFICE/ COMPUTER TABLE**



**8. SET BAR TABLE WITH 4 CHAIRS**



**9. SINGLE SOFA**



**10. SOFA, 3-SEATER**



**11. STEP LADDER (FOLDABLE)**



**12. TEACHER'S TABLE (WORKSTATION)**



**13. THEATER SEAT WITH ARM REST**

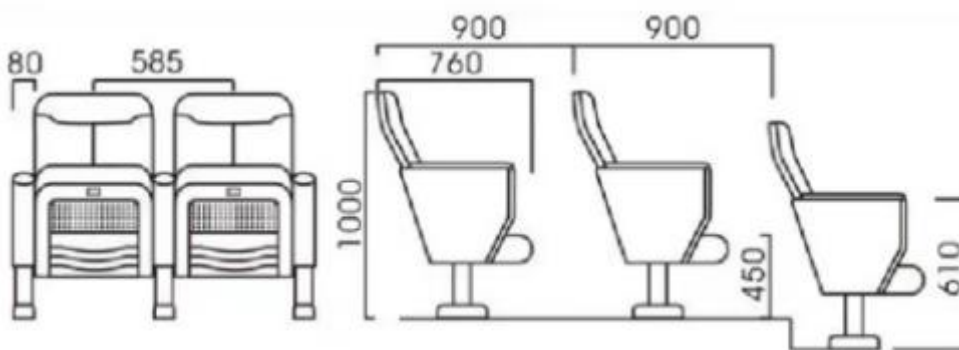

**14 & 15. VERTICAL FILING CABINET (GLASS DOOR) 1 & 2**



**16. VERTICAL FILING CABINET 1**



aluminum handle  
with integrated  
name label holder

full drawer height  
metal divider

**17. VERTICAL FILING CABINET 2**



PANTONE®  
13-1530

DIVIDER



# ***Section VIII. Checklist of Technical and Financial Documents***

## **I. TECHNICAL COMPONENT ENVELOPE**

**(Bidder should submit only one (1) copy labeled “ORIGINAL”)**

### ***Class “A” Documents***

#### **Legal Documents**

- (a) Valid and updated PhilGEPS Certificate of Platinum Registration and Membership ONLY for purposes of determining eligibility in accordance with GPPB Resolution No. 015-2021. Please see attached sample of Revised PhilGEPS Certificate of Platinum Registration and Membership;

#### **Technical Documents**

- (b) Statement of the prospective bidder of all its ongoing government and private contracts, including contracts awarded but not yet started, if any, whether similar or not similar in nature and complexity to the contract to be bid; **and**
- (c) Statement of the bidder’s Single Largest Completed Contract (SLCC) similar to the contract to be bid, except under conditions provided for in Sections 23.4.1.3 and 23.4.2.4 of the 2016 revised IRR of RA No. 9184, within the relevant period as provided in the Bidding Documents; **and**
- (d) Original copy of Bid Security. If in the form of a Surety Bond, submit also a certification issued by the Insurance Commission;  
**or**  
Original copy of Notarized Bid Securing Declaration; **and**
- (e) Conformity with the Technical Specifications, which may include production/delivery schedule, manpower requirements, and/or after-sales/parts, if applicable; **and**
- (f) Original duly signed Omnibus Sworn Statement (OSS);

**and** if applicable, Original Notarized Secretary’s Certificate in case of a corporation, partnership, or cooperative; or Original Special Power of Attorney of all members of the joint venture giving full power and authority to its officer to sign the OSS and do acts to represent the Bidder.

#### **Financial Documents**

- (g) The Supplier’s audited financial statements, showing, among others, the Supplier’s total and current assets and liabilities, stamped “received” by the BIR or its duly accredited and authorized institutions, for the preceding calendar year which should not be earlier than two (2) years from the date of bid submission; **and**
- (h) The prospective bidder’s computation of Net Financial Contracting Capacity (NFCC);

**or**  
A committed Line of Credit from a Universal or Commercial Bank in lieu of its NFCC computation.

***Class “B” Documents***

- (i) If applicable, a duly signed joint venture agreement (JVA) in case the joint venture is already in existence;

**or**

duly notarized statements from all the potential joint venture partners stating that they will enter into and abide by the provisions of the JVA in the instance that the bid is successful.

***Other documentary requirements under RA No. 9184 (as applicable)***

- (j) *[For foreign bidders claiming by reason of their country’s extension of reciprocal rights to Filipinos]* Certification from the relevant government office of their country stating that Filipinos are allowed to participate in government procurement activities for the same item or product.
- (k) Certification from the DTI if the Bidder claims preference as a Domestic Bidder or Domestic Entity.

**II. FINANCIAL COMPONENT ENVELOPE**

**(Bidder should submit only one (1) copy labeled “ORIGINAL”)**

- (a) Original of duly signed and accomplished Financial Bid Form; **and**
- (b) Original of duly signed and accomplished Price Schedule(s).

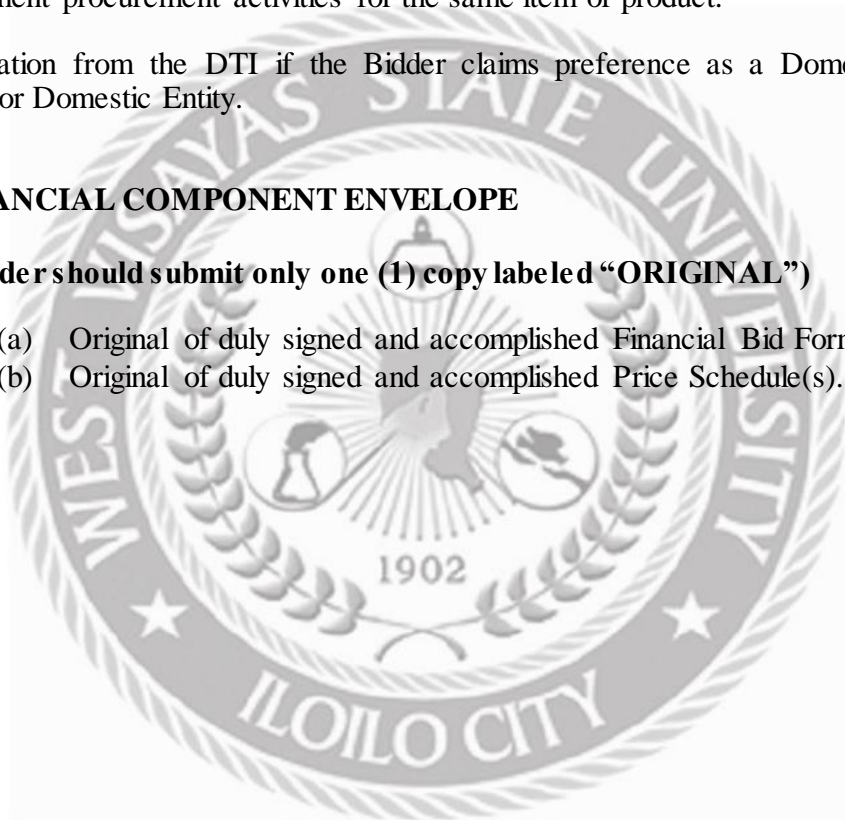

**Bid Form for the Procurement of Goods**  
*[shall be submitted with the Bid]*

**BID FORM**

Date : \_\_\_\_\_

Project Identification No. : \_\_\_\_\_

To: *[name and address of Procuring Entity]*

Having examined the Philippine Bidding Documents (PBDs) including the Supplemental or Bid Bulletin Numbers *[insert numbers]*, the receipt of which is hereby duly acknowledged, we, the undersigned, offer to *[supply/deliver/perform]* *[description of the Goods]* in conformity with the said PBDs for the sum of *[total Bid amount in words and figures]* or the total calculated bid price, as evaluated and corrected for computational errors, and other bid modifications in accordance with the Price Schedules attached herewith and made part of this Bid. The total bid price includes the cost of all taxes, such as, but not limited to: *[specify the applicable taxes, e.g. (i) value added tax (VAT), (ii) income tax, (iii) local taxes, and (iv) other fiscal levies and duties]*, which are itemized herein or in the Price Schedules,

If our Bid is accepted, we undertake:

- a. to deliver the goods in accordance with the delivery schedule specified in the Schedule of Requirements of the Philippine Bidding Documents (PBDs);
- b. to provide a performance security in the form, amounts, and within the times prescribed in the PBDs;
- c. to abide by the Bid Validity Period specified in the PBDs and it shall remain binding upon us at any time before the expiration of that period.

*[Insert this paragraph if Foreign-Assisted Project with the Development Partner:*

Commissions or gratuities, if any, paid or to be paid by us to agents relating to this Bid, and to contract execution if we are awarded the contract, are listed below:

Name and address Of agent	Amount Currency	Purpose of Commission or gratuity
_____	_____	_____
_____	_____	_____
_____	_____	_____

(if none, state "None") ]

Until a formal Contract is prepared and executed, this Bid, together with your written acceptance thereof and your Notice of Award, shall be binding upon us.

We understand that you are not bound to accept the Lowest Calculated Bid or any Bid you may receive.

We certify/confirm that we comply with the eligibility requirements pursuant to the PBDs.

The undersigned is authorized to submit the bid on behalf of *[name of the bidder]* as evidenced by the attached *[state the written authority]*.

We acknowledge that failure to sign each and every page of this Bid Form, including the attached Schedule of Prices, shall be a ground for the rejection of our bid.

Name: \_\_\_\_\_

Legal capacity: \_\_\_\_\_

Signature: \_\_\_\_\_



Duly authorized to sign the Bid for and behalf of: \_\_\_\_\_

Date: \_\_\_\_\_

**Price Schedule for Goods Offered from Within the Philippines**  
*[shall be submitted with the Bid if bidder is offering goods from within the Philippines]*

**For Goods Offered from Within the Philippines**

Name of Bidder \_\_\_\_\_ **Project ID No. 2024-30** Page **1 of 1**

1	2	3	4	5	6	7	8	9	10
Item	Description	Country of origin	Quantity	Unit price EXWP per item	Transportation and all other costs incidental to delivery, per item	Sales and other taxes payable if Contract is awarded, per item	Cost of Incidental Services, if applicable, per item	Total Price, per unit (col 5+6+7+8)	Total Price delivered Final Destination (col 9) x (col 4)
1.	Computer Table		25						
2.	Executive Desk		1						
3.	Executive Office Table		11						
4.	Full Fabric Partition Panel with door		1						
5.	Low Office Cabinet		3						
6.	Office Table		1						
7.	Office/ Computer Table		6						
8.	Set Bar Table with 4 Chairs		6						
9.	Single Sofa		4						
10.	Sofa, 3-seater		3						
11.	Step Ladder (Foldable)		4						
12.	Teacher's Table (Workstation)		53						
13.	Theater Seat with Arm Rest		25						
14.	Vertical Filing Cabinet (Glass Door) 1		8						
15.	Vertical Filing Cabinet (Glass Door) 2		2						
16.	Vertical Filing Cabinet 1		4						
17.	Vertical Filing Cabinet 2		5						
	----Nothing Follows-----								
	<b>TOTAL BID PRICE</b>							<b>PhP</b>	

Name: \_\_\_\_\_

Legal Capacity: \_\_\_\_\_

Signature: \_\_\_\_\_

Duly authorized to sign the Bid for and behalf of: \_\_\_\_\_

Date: \_\_\_\_\_

*Suggested Format/ Template*

Name of the Procuring Entity: \_\_\_\_\_

Project: \_\_\_\_\_

Location of the Project: \_\_\_\_\_

**Statement of all Ongoing Government & Private Contracts including contracts awarded but not yet started**

Business Name: \_\_\_\_\_

Business Address: \_\_\_\_\_

Name of Contract	Date of Contract	Contract Duration	Owner's Name and Address	Kind of Goods	Date of Delivery	Amount		End-user's acceptance or official receipt(s) or sales invoice issued for the contract
						Contract	Value of Outstanding Contract	
<b><u>Government</u></b>								
<b><u>Private</u></b>								
<b>Total Cost</b>								

Note: This statement shall be supported with:

1. Notice of Award (NOA)
2. Contract
3. Notice to Proceed (NTP)
4. And other documents, if necessary

Name: \_\_\_\_\_

Legal Capacity: \_\_\_\_\_

Signature: \_\_\_\_\_

Duly authorized to sign the Bid for and behalf of: \_\_\_\_\_

Date: \_\_\_\_\_

*Suggested Format/ Template*

Name of the Procuring Entity: \_\_\_\_\_  
 Project: \_\_\_\_\_  
 Location of the Project: \_\_\_\_\_

**Statement of Bidder’s Single Largest Completed Contract (SLCC) similar to the Contract to be bid which should be at least fifty percent (50%) of the ABC**

Business Name: \_\_\_\_\_  
 Business Address: \_\_\_\_\_

Name of Contract	a. Owner’s Name b.Owner’s Name Address c.Telephone Nos.	Nature of Work	Bidder’s Role		a. Amount of Award b.Amount of Completion c.Duration	a. Date Awarded b.Contract Effectivity c.Date Completed
			Description	%		

- Note: This statement shall be supported with:
- 1. Contract**
  - 2. Certificate of completion/ acceptance or**
  - 3. Official receipt issued to the Procuring Entity**

Name: \_\_\_\_\_  
 Legal Capacity: \_\_\_\_\_  
 Signature: \_\_\_\_\_  
 Duly authorized to sign the Bid for and behalf of: \_\_\_\_\_  
 Date: \_\_\_\_\_

**Performance Securing Declaration (Revised)**

*[if used as an alternative performance security but it is not required to be submitted with the Bid, as it shall be submitted within ten (10) days after receiving the Notice of Award]*

REPUBLIC OF THE PHILIPPINES)  
CITY OF \_\_\_\_\_ ) S.S.

**PERFORMANCE SECURING DECLARATION**

Invitation to Bid: [Insert Reference Number indicated in the Bidding Documents]  
To: [Insert name and address of the Procuring Entity]

I/We, the undersigned, declare that:

1. I/We understand that, according to your conditions, to guarantee the faithful performance by the supplier/distributor/manufacturer/contractor/consultant of its obligations under the Contract, I/we shall submit a Performance Securing Declaration within a maximum period of ten (10) calendar days from the receipt of the Notice of Award prior to the signing of the Contract.
2. I/We accept that: I/we will be automatically disqualified from bidding for any procurement contract with any procuring entity for a period of one (1) year for the first offense, or two (2) years **for the second offense**, upon receipt of your Blacklisting Order if I/We have violated my/our obligations under the Contract;
3. I/We understand that this Performance Securing Declaration shall cease to be valid upon:
  - a. issuance by the Procuring Entity of the Certificate of Final Acceptance, subject to the following conditions:
    - i. Procuring Entity has no claims filed against the contract awardee;
    - ii. It has no claims for labor and materials filed against the contractor; and
    - iii. Other terms of the contract; or
  - b. replacement by the winning bidder of the submitted PSD with a performance security in any of the prescribed forms under Section 39.2 of the 2016 revised IRR of RA No. 9184 as required by the end-user.

**IN WITNESS WHEREOF**, I/We have hereunto set my/our hand/s this \_\_\_\_\_ day of [month] [year] at [place of execution].

*[Insert NAME OF BIDDER OR ITS AUTHORIZED REPRESENTATIVE]*  
*[Insert signatory's legal capacity]*  
Affiant

**[Jurat]**  
*[Format shall be based on the latest Rules on Notarial Practice]*

**Omnibus Sworn Statement (Revised)**  
*[shall be submitted with the Bid]*

---

REPUBLIC OF THE PHILIPPINES )  
CITY/MUNICIPALITY OF \_\_\_\_\_ ) S.S.

**AFFIDAVIT**

I, [Name of Affiant], of legal age, [Civil Status], [Nationality], and residing at [Address of Affiant], after having been duly sworn in accordance with law, do hereby depose and state that:

1. *[Select one, delete the other:]*

*[If a sole proprietorship:]* I am the sole proprietor or authorized representative of [Name of Bidder] with office address at [address of Bidder];

*[If a partnership, corporation, cooperative, or joint venture:]* I am the duly authorized and designated representative of [Name of Bidder] with office address at [address of Bidder];

2. *[Select one, delete the other:]*

*[If a sole proprietorship:]* As the owner and sole proprietor, or authorized representative of [Name of Bidder], I have full power and authority to do, execute and perform any and all acts necessary to participate, submit the bid, and to sign and execute the ensuing contract for [Name of the Project] of the [Name of the Procuring Entity], as shown in the attached duly notarized Special Power of Attorney;

*[If a partnership, corporation, cooperative, or joint venture:]* I am granted full power and authority to do, execute and perform any and all acts necessary to participate, submit the bid, and to sign and execute the ensuing contract for [Name of the Project] of the [Name of the Procuring Entity], as shown in the attached [state title of attached document showing proof of authorization (e.g., duly notarized Secretary's Certificate, Board/Partnership Resolution, or Special Power of Attorney, whichever is applicable:)];

3. [Name of Bidder] is not "blacklisted" or barred from bidding by the Government of the Philippines or any of its agencies, offices, corporations, or Local Government Units, foreign government/foreign or international financing institution whose blacklisting rules have been recognized by the Government Procurement Policy Board, **by itself or by relation, membership, association, affiliation, or controlling interest with another blacklisted person or entity as defined and provided for in the Uniform Guidelines on Blacklisting;**

4. Each of the documents submitted in satisfaction of the bidding requirements is an authentic copy of the original, complete, and all statements and information provided therein are true and correct;

5. [Name of Bidder] is authorizing the Head of the Procuring Entity or its duly authorized representative(s) to verify all the documents submitted;

6. *[Select one, delete the rest:]*

*[If a sole proprietorship:]* The owner or sole proprietor is not related to the Head of the Procuring Entity, members of the Bids and Awards Committee (BAC), the Technical Working Group, and the BAC Secretariat, the head of the Project Management Office or the end-user unit, and the project consultants by consanguinity or affinity up to the third civil degree;

*[If a partnership or cooperative:]* None of the officers and members of [Name of Bidder] is related to the Head of the Procuring Entity, members of the Bids and Awards Committee (BAC), the Technical Working Group, and the BAC Secretariat, the head of the Project Management Office or the end-user unit, and the project consultants by consanguinity or affinity up to the third civil degree;

*[If a corporation or joint venture:]* None of the officers, directors, and controlling stockholders of [Name of Bidder] is related to the Head of the Procuring Entity, members of the Bids and Awards Committee (BAC), the Technical Working Group, and the BAC Secretariat, the head of the Project Management Office or the end-user unit, and the project consultants by consanguinity or affinity up to the third civil degree;

7. [Name of Bidder] complies with existing labor laws and standards; and

8. *[Name of Bidder]* is aware of and has undertaken the responsibilities as a Bidder in compliance with the Philippine Bidding Documents, which includes:
  - a. Carefully examining all of the Bidding Documents;
  - b. Acknowledging all conditions, local or otherwise, affecting the implementation of the Contract;
  - c. Making an estimate of the facilities available and needed for the contract to be bid, if any; and
  - d. Inquiring or securing Supplemental/Bid Bulletin(s) issued for the *[Name of the Project]*.
9. *[Name of Bidder]* did not give or pay directly or indirectly, any commission, amount, fee, or any form of consideration, pecuniary or otherwise, to any person or official, personnel or representative of the government in relation to any procurement project or activity.

**10. In case advance payment was made or given, failure to perform or deliver any of the obligations and undertakings in the contract shall be sufficient grounds to constitute criminal liability for Swindling (Estafa) or the commission of fraud with unfaithfulness or abuse of confidence through misappropriating or converting any payment received by a person or entity under an obligation involving the duty to deliver certain goods or services, to the prejudice of the public and the government of the Philippines pursuant to Article 315 of Act No. 3815 s. 1930, as amended, or the Revised Penal Code.**

IN WITNESS WHEREOF, I have hereunto set my hand this \_\_\_ day of \_\_\_, 20\_\_ at \_\_\_\_\_, Philippines.

*[Insert NAME OF BIDDER OR ITS AUTHORIZED REPRESENTATIVE]*

*[Insert signatory's legal capacity]*  
Affiant

**[Jurat]**

*[Format shall be based on the latest Rules on Notarial Practice]*

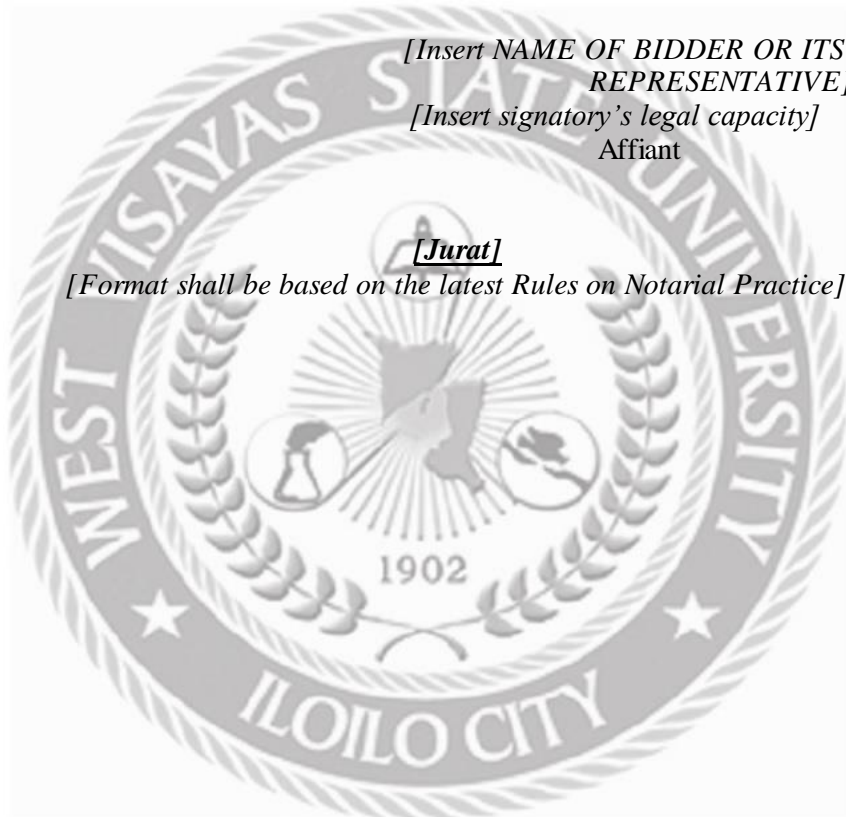

## **Bid Securing Declaration Form**

*[shall be submitted with the Bid if bidder opts to provide this form of bid security]*

---

REPUBLIC OF THE PHILIPPINES)  
CITY OF \_\_\_\_\_) S.S.

### **BID SECURING DECLARATION** **Project Identification No.: [Insert number]**

To: *[Insert name and address of the Procuring Entity]*

I/We, the undersigned, declare that:

1. I/We understand that, according to your conditions, bids must be supported by a Bid Security, which may be in the form of a Bid Securing Declaration.
2. I/We accept that: (a) I/we will be automatically disqualified from bidding for any procurement contract with any procuring entity for a period of two (2) years upon receipt of your Blacklisting Order; and, (b) I/we will pay the applicable fine provided under Section 6 of the Guidelines on the Use of Bid Securing Declaration, within fifteen (15) days from receipt of the written demand by the procuring entity for the commission of acts resulting to the enforcement of the bid securing declaration under Sections 23.1(b), 34.2, 40.1 and 69.1, except 69.1(f), of the IRR of RA No. 9184; without prejudice to other legal action the government may undertake.
3. I/We understand that this Bid Securing Declaration shall cease to be valid on the following circumstances:
  - a. Upon expiration of the bid validity period, or any extension thereof pursuant to your request;
  - b. I am/we are declared ineligible or post-disqualified upon receipt of your notice to such effect, and (i) I/we failed to timely file a request for reconsideration or (ii) I/we filed a waiver to avail of said right; and
  - c. I am/we are declared the bidder with the Lowest Calculated Responsive Bid, and I/we have furnished the performance security and signed the Contract.

IN WITNESS WHEREOF, I/We have hereunto set my/our hand/s this \_\_\_\_ day of *[month]* *[year]* at *[place of execution]*.

*[Insert NAME OF BIDDER OR ITS AUTHORIZED  
REPRESENTATIVE]*

*[Insert signatory's legal capacity]*

Affiant

**[Jurat]**

*[Format shall be based on the latest Rules on Notarial Practice]*

**Contract Agreement Form for the Procurement of Goods (Revised)**  
***[Not required to be submitted with the Bid, but it shall be submitted within ten (10) days after receiving the Notice of Award]***

---

**CONTRACT AGREEMENT**

THIS AGREEMENT made the \_\_\_\_ day of \_\_\_\_\_ 20\_\_\_\_ between [name of PROCURING ENTITY] of the Philippines (hereinafter called “the Entity”) of the one part and [name of Supplier] of [city and country of Supplier] (hereinafter called “the Supplier”) of the other part;

WHEREAS, the Entity invited Bids for certain goods and ancillary services, particularly [brief description of goods and services] and has accepted a Bid by the Supplier for the supply of those goods and services in the sum of *[contract price in words and figures in specified currency]* (hereinafter called “the Contract Price”).

NOW THIS AGREEMENT WITNESSETH AS FOLLOWS:

1. In this Agreement words and expressions shall have the same meanings as are respectively assigned to them in the Conditions of Contract referred to.
2. The following documents as required by the 2016 revised Implementing Rules and Regulations of Republic Act No. 9184 shall be deemed to form and be read and construed as integral part of this Agreement, viz.:
  - i. Philippine Bidding Documents (PBDs);
    - i. Schedule of Requirements;
    - ii. Technical Specifications;
    - iii. General and Special Conditions of Contract; and
    - iv. Supplemental or Bid Bulletins, if any
  - ii. Winning bidder’s bid, including the Eligibility requirements, Technical and Financial Proposals, and all other documents or statements submitted;  
  
Bid form, including all the documents/statements contained in the Bidder’s bidding envelopes, as annexes, and all other documents submitted (*e.g.*, Bidder’s response to request for clarifications on the bid), including corrections to the bid, if any, resulting from the Procuring Entity’s bid evaluation;
  - iii. Performance Security;
  - iv. Notice of Award of Contract; and the Bidder’s conforme thereto; and
  - v. Other contract documents that may be required by existing laws and/or the Procuring Entity concerned in the PBDs. **Winning bidder agrees that additional contract documents or information prescribed by the GPPB that are subsequently required for submission after the contract execution, such as the Notice to Proceed, Variation Orders, and Warranty Security, shall likewise form part of the Contract.**
3. In consideration for the sum of *[total contract price in words and figures]* or such other sums as may be ascertained, *[Named of the bidder]* agrees to *[state the object of the contract]* in accordance with his/her/its Bid.
4. The *[Name of the procuring entity]* agrees to pay the above-mentioned sum in accordance with the terms of the Bidding.

IN WITNESS whereof the parties hereto have caused this Agreement to be executed in accordance with the laws of the Republic of the Philippines on the day and year first above written.

*[Insert Name and Signature]*  
*[Insert Signatory’s Legal Capacity]*

*for:*  
*[Insert Procuring Entity]*

*[Insert Name and Signature]*  
*[Insert Signatory’s Legal Capacity]*

*for:*  
*[Insert Name of Supplier]*

**Acknowledgment**

*[Format shall be based on the latest Rules on Notarial Practice]*





Republic of the Philippines



Government Procurement Policy Board